



WW-SRCB02
REPLACES SA101N60C-LP

PAN-WAY®
NON-METALLIC
SURFACE
RACEWAY

TABLE OF
CONTENTS

System Overview	A	System Overview
Quick Selection Guide	B	Quick Selection Guide
Office Furniture Raceway	C	Office Furniture
Cove Raceway	D	Cove
TG-70 Raceway	E	TG-70
T-70 and Twin-70 Raceway	F	T-70 & Twin-70
T-45 Raceway	G	T-45
ULTIMATE ID™ Network Labeling System	H	Ultimate ID System
Faceplates, Surface Mount Outlet Boxes and Labeling Administration	J	Faceplates, Boxes & Labeling
LD Profile Raceway	K	LD Profile
T130 Raceway	L	T130
PAN-POLE™ Outlet Pole	M	Outlet Pole
Technical Information	N	Technical Info
Index	O	Index

TABLE OF CONTENTS

System Overview

System Overview	A1-A2
------------------------------	--------------

Quick Selection Guide

Quick Selection Guide	B1-B3
------------------------------------	--------------

Office Furniture

PAN-WAY® Office Furniture Non-Metallic Surface Raceway	C1
Office Furniture Raceway Roadmap	C2-C3
Office Furniture Configurations	C4-C5
PAN-WAY® Office Furniture Raceway System	C6
PAN-WAY® Office Furniture Raceway Fittings	C6-C8
Component Labels for Office Furniture Raceway Faceplates	C9
Quick Wire Fill Capacities for Office Furniture Raceway	C10

Cove Raceway

PAN-WAY® Cove Non-Metallic Surface Raceway	D1
Cove Raceway Roadmap	D2-D3
Cove Configurations	D4-D5
PAN-WAY® Cove Raceway System	D6
PAN-WAY® Cove Raceway Fittings	D7
Quick Wire Fill Capacities for Cove Raceway	D8

TG-70 Raceway

PAN-WAY® TG-70 Non-Metallic Surface Raceway	E1
TG-70 Raceway Roadmap	E2-E3
TG-70 Configurations	E4-E5
PAN-WAY® TG-70 Raceway System	E6
PAN-WAY® TG-70 Raceway Fittings	E7
PAN-WAY® TG-70 Raceway Accessories	E8
Quick Wire Fill Capacities for TG-70 Raceway	E9

T-70 and Twin-70 Raceway

PAN-WAY® T-70 and Twin-70 Non-Metallic Surface Raceway	F1
T-70 Raceway Roadmap	F2-F3
T-70 Configurations	F4-F5
Twin-70 Raceway Roadmap	F6-F7
PAN-WAY® T-70 Raceway System	F8
PAN-WAY® T-70 Raceway Fittings	F8-F9
Tee Insert Configurations	F9
PAN-WAY® Twin-70 Raceway System	F10
PAN-WAY® Twin-70 Fittings	F11
PAN-WAY® T-70 and Twin-70 Raceway Accessories	F12
Quick Wire Fill Capacities for T-70 Raceway	F13
Quick Wire Fill Capacities for Twin-70 Raceway	F14

TABLE OF CONTENTS

T-45 Raceway

PAN-WAY® T-45 Non-Metallic Surface Raceway	G1
T-45 Raceway Roadmap	G2-G3
T-45 Configurations	G4-G5
PAN-WAY® T-45 Raceway System	G6
PAN-WAY® T-45 Raceway Fittings	G7
Quick Wire Fill Capacities for T-45 Raceway	G8

ULTIMATE ID™ Network Labeling System

ULTIMATE ID™ Network Labeling System for Outlets	H1
How <i>ULTIMATE ID™</i> Network Labeling System for Outlets (Faceplates/Surface Mount Boxes) assists in compliance with TIA/EIA-606-A Standard	H1
Selection Chart for Using <i>PAN-WAY®</i> Surface Raceway with <i>ULTIMATE ID™</i> Faceplates	H2
<i>MINI-COM®</i> <i>ULTIMATE ID™</i> Executive Series Faceplates	H3
<i>MINI-COM®</i> <i>ULTIMATE ID™</i> Classic Series Faceplates	H4
<i>MINI-COM®</i> <i>ULTIMATE ID™</i> Sloped Snap-On Faceplates	H5
<i>ULTIMATE ID™</i> Network Labeling System Identification Products	H6
How <i>ULTIMATE ID™</i> Network Labeling System, <i>PANAĀEA®</i> LS7 Hand-Held Thermal Transfer Printer and Laser/Ink Jet Labels assist in compliance with the TIA/EIA-606-A Standard	H6
<i>PANAĀEA®</i> LS7 Hand-Held Thermal Transfer Printer and Label Cassettes	H7
<i>ULTIMATE ID™</i> LS7 Hand-Held Thermal Transfer Printer Label Cassettes	H7
<i>ULTIMATE ID™</i> Non-Laminated Label Cassette for use with <i>ULTIMATE ID™</i> Applications	H7
Cable Marking Cassettes for <i>PANAĀEA®</i> LS7 Hand-Held Thermal Transfer Printer	H7
<i>ULTIMATE ID™</i> Laser/Ink Jet Labels	H8
<i>ULTIMATE ID™</i> Labeling Software for WINDOWS^	H8
<i>PAN-MARK®</i> for WINDOWS^ Labeling Software	H9
<i>ULTIMATE ID™</i> Write-On Labels	H9
Permanent Marking Pens	H10
<i>ULTIMATE ID™</i> Replacement Label Covers and Screw Covers	H10
<i>ULTIMATE ID™</i> Icons	H10

Faceplates, Boxes & Labeling Administration

PAN-WAY® Snap-On Faceplates and Surface Mount Outlet Boxes	J1
<i>PAN-WAY®</i> <i>FAST-SNAP™</i> Surface Mount Outlet Boxes	J2
<i>PAN-WAY®</i> Classic Series Snap-On Faceplates for Use With <i>MINI-COM®</i> Modules	J2
<i>PAN-WAY®</i> Classic Series Snap-On Faceplates for Use With <i>MINI-COM®</i> Inserts	J3
<i>PAN-WAY®</i> Classic Series Snap-On Faceplates for Communication/Power	J3
<i>NETKEY™</i> Snap-on “Sloped” (Keystone) Faceplates	J4
<i>NETKEY™</i> Snap-on “Flush” Universal (Keystone) Faceplates	J4
Component Labels for Snap-On “Sloped” (Keystone) Faceplates and Snap-on “Flush” Universal (Keystone) Faceplates	J4
<i>PAN-WAY®</i> Snap-On Faceplates for Avaya®/Comscope® Communication Modules	J5
Component Labels for Avaya®/Comscope® Communication Modules	J5
<i>PAN-WAY®</i> Snap-On Faceplates for Nordx/CDT® Communication Modules	J6
Component Labels for Nordx/CDT® Communication Modules	J6
<i>PAN-WAY®</i> Low Voltage Surface Mount Outlet Boxes	J7
<i>PAN-WAY®</i> Power Rated Surface Mount Outlet Boxes	J8-J9
<i>PAN-WAY®</i> Classic Series Power and Communication Faceplates	J10
Component Labels for Classic Series Power and Communication Faceplates	J10
<i>PAN-WAY®</i> Stainless Steel Faceplates	J11
<i>PAN-WAY®</i> Electrical Outlets	J11
Raceway Adapters for LD Raceway	J11

^Avaya is a registered trademark of Avaya, Inc.

*CommScope is a registered trademark of Commscope Properties, L.L.C.

*Nordx/CDT is a registered trademark of Nordx/CDT, Inc.

*WINDOWS is a registered trademark of Microsoft Corp. in the United States and other countries.

TABLE OF CONTENTS

Selection Chart for using *PAN-WAY*® Surface Raceway with *PAN-WAY*® Surface Mount Outlet BoxesJ12

Labeling & Administration	J13
<i>PANAĀEA</i> ® LS7 Hand-Held Thermal Transfer Printer and Accessories	J14
<i>VIPER</i> ™ LS6 Portable Thermal Transfer Printer and Accessories	J14
<i>PAN-MARK</i> ® for WINDOWS^ Labeling Software	J15
<i>EASY-MARK</i> ™ Labeling Software	J15
<i>ULTIMATE ID</i> ™ Labeling Software for WINDOWS^	J16
<i>ID GENERATOR</i> ™ Software	J16
Component Labels for Laser/Ink Jet Desktop Printers Supplied on 8.5" x 11" Sheets	J17
Component Labels for <i>VIPER</i> ™ LS6 Portable Thermal Transfer Printer Supplied on Rolls	J17
Component Cassettes for <i>PANAĀEA</i> ® LS7 Hand-Held Thermal Transfer Printer	J17

LD Profile Raceway

<i>PAN-WAY</i>® LD Profile Non-Metallic Surface Raceway	K1
LD2P10 Profile Raceway RoadmapK2-K3
LD2P10 Raceway ConfigurationsK4-K5
LD Profile Raceway RoadmapK6-K7
LD Raceway ConfigurationsK8-K9
LDP Profile Raceway RoadmapK10-K11
LDP Raceway ConfigurationsK12
<i>PAN-WAY</i> ® Type LD2P10 Multi-Channel Surface RacewayK13
Multi-Channel Fittings for LD2P10K13
<i>PAN-WAY</i> ® Type LD Surface RacewayK14
<i>PAN-WAY</i> ® Type LDP Surface RacewayK15
<i>PAN-WAY</i> ® Type LDS Surface RacewayK16
Method for Bending Type LDS Raceway (Low Voltage Applications)K16
Standard Fittings for Low Voltage ApplicationsK17
One Inch Bend Radius Fittings for TIA/EIA ComplianceK18
Power Rated Fittings for Power to 600V – LDP/LDS/LD2P Raceway OnlyK19
Quick Wire Fill Capacities for LD Profile RacewayK20
Floor GuardK21
<i>PAN-WAY</i> ® Surface Raceway Cutting ToolK21
Foam TapeK22
LDP/LDS/LD2P Raceway Installation ToolsK22

T130 Raceway

<i>PAN-WAY</i>® Type T130 Non-Metallic Surface Raceway	L1
Type T130 Raceway RoadmapL2-L3
Type T130 ConfigurationsL4
<i>PAN-WAY</i> ® Type T130 Surface Raceway SystemL5
<i>PAN-WAY</i> ® Type T130 Raceway FittingsL6
Type T Raceway AccessoriesL7
<i>PAN-WAY</i> ® Pre-Cut Cover and Type T Outlet BoxL7
<i>PAN-WAY</i> ® Pre-Cut Covers for Snap-On Modular Furniture FaceplatesL7
T130 Hanging Device BracketsL8
T130 Snap-On FaceplatesL8
Quick Wire Fill Capacities for Type T130 RacewayL9

TABLE OF CONTENTS

Outlet Pole

PAN-POLE™ Aluminum Outlet PoleM1
PAN-POLE™ Power and Communication PoleM2
PAN-POLE™ Communication PoleM3
PAN-POLE™ Extension KitsM4
PAN-POLE™ Power Addition Kits and Standard Faceplate Bracket (for Data)M4
PAN-POLE™ Aluminum Outlet Pole Replacement PartsM5
Quick Wire Fill Capacities for *PAN-POLE™* Aluminum Outlet PolesM6

Technical Information

Technical InformationN1
TIA/EIA-568-B Commercial Building Telecommunications Cabling StandardN1
TIA/EIA-569-B Commercial Building Standard for Telecommunications Pathways and SpacesN1-N2
TIA/EIA-606-A Administration Standard for Commercial Telecommunications InfrastructureN3
ISO 9001 and ISO 14001N4
Mounting GuidelinesN4
FlammabilityN4
Physical PropertiesN5
Raceway Typical SpecificationsN6-N8
UL-CSA Performance RequirementsN9
UL 5C Performance RequirementsN10
NEC Article 388 (2002) Brief ExplanationN11

Index

IndexO1-O3

Total Routing Solution

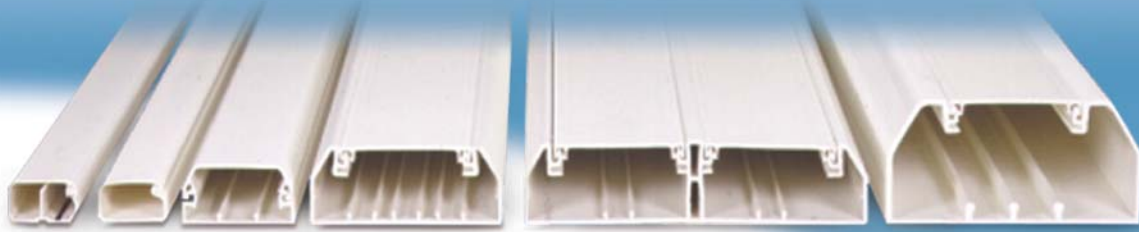

PANDUIT® offers the most complete line of non-metallic surface raceway. PAN-WAY® Surface Raceway provides maximum flexibility for routing both power and data cabling, seamlessly integrated for a total routing solution.

- *PAN-WAY®* Power Rated Raceway Systems provide extreme tamper resistance, yet are accessible for cost effective moves, adds and changes
- *PAN-WAY®* Fittings are designed to maintain the TIA/EIA 568-B and 569-B required minimum bend radius for high performance copper and fiber optic cabling systems in data applications
- Snap-On Faceplates and *FAST-SNAP™* Boxes install without the use of screws for faster installation and superior aesthetics
- Exclusive *PAN-WAY®* T-70 *WORKSTATION OUTLET CENTER™* with Snap-On Faceplates facilitate installation, provide maximum cable capacity and can be easily positioned to meet workstation requirements
- The complete line of power rated raceways, fittings, outlet boxes and accessories comply with stringent UL5A and CSA C22.2 No. 62.1-03 approvals for use up to 600V



Snap-On Faceplates with
FAST-SNAP™ Boxes



T-70 *WORKSTATION*
OUTLET CENTER™



T-70 Raceway with
Snap-On Faceplates

PANDUIT® is a Global Leader Providing Innovative Networking Solutions to Enable Technology.

- ***Raceway Systems***
- ***Modular Twisted Pair and Fiber Optic Connectors***
- ***Outlets***
- ***Racks and Cable Management***
- ***Fiber Routing Systems***
- ***Physical Layer Management Systems***
- ***Zone Cabling Systems***
- ***Network Identification Systems***
- ***Network Cable Ties and Accessories***
- ***Network Grounding Systems***

PAN-WAY® Non-Metallic Surface Raceway System Overview

PAN-WAY® Non-Metallic Surface Raceways provide maximum flexibility for routing, protecting and concealing high performance copper, voice, video, fiber optic and power cabling which allows for moves, adds and changes for future upgrades. All *PANDUIT®* Surface Raceways include a full complement of fittings that are designed to maintain the proper bend radius control required for high performance copper and fiber optic cabling systems. *PANDUIT®* raceway systems include transition fittings that facilitate seamless integration of one *PANDUIT®* raceway system to another.

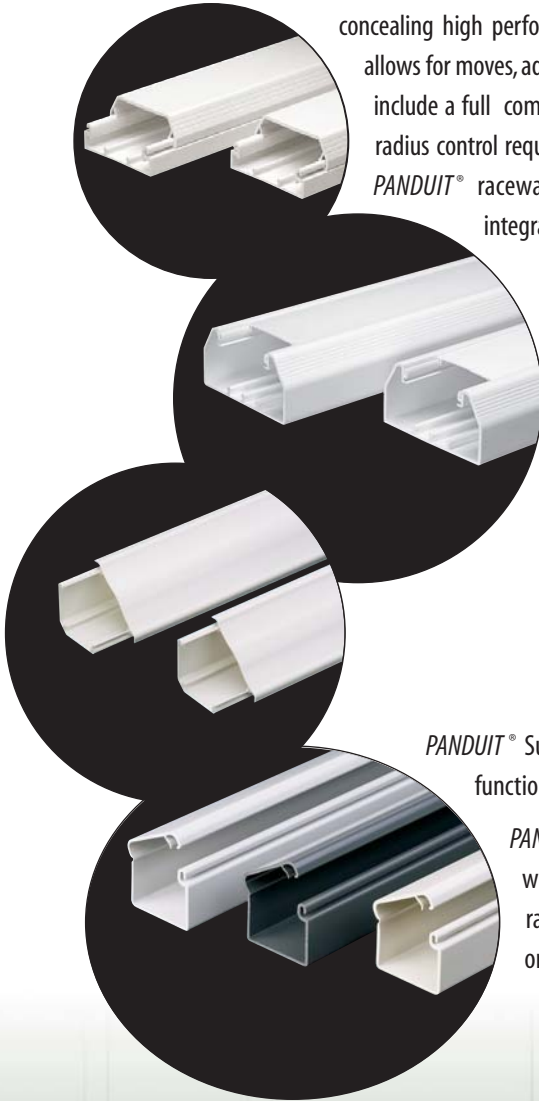

- Aesthetically pleasing
- Lightweight
- Tamper resistant
- Bend Radius Control
- Resists dents and conceals scratches and chips
- Ease of modifications and additions
- Lowest installed cost

PANDUIT® Surface Raceways are designed with attention to form, as well as function and are aesthetically pleasing to blend with any decor.

PANDUIT® Surface Raceway provides you with a variety of choices when selecting your data and electrical terminations. All of the raceways accept either NEMA standard 70mm "screw-on" faceplates or superior *PANDUIT®* "snap-on" faceplates.

GLOBAL SERVICES AND SUPPORT

PACT™ PROGRAM



The *PACT™* Program brings together a community of best in class partners who share a vision — to provide the optimum business-focused network solutions based on a framework of open architecture, designed specifically to support critical network applications and address unique vertical market considerations.

Under a traditional, vertically integrated business model, customers typically looked to one vendor to satisfy all their requirements, from building services and network management to consultancy and deployment. This approach not only limits choices, but also the level of product and technology innovation available, ultimately restricting the customer's ability to compete and deliver a competitive return on investment.

PANDUIT® is working with customers to develop application driven product solution sets, in support of Voice over IP (VOIP), Ethernet to the home or office, and storage area networking deployment. Industry standards help to ensure that solutions work together. However, the unified approach goes one step further by testing the solutions for interoperability, functionality and performance, providing a further assurance that the end-to-end system will function at an optimum level.

PANDUIT® CERTIFIED INSTALLER PROGRAM



The *PANDUIT®* Certified Installer (PCI) Program was created to ensure that end-to-end *PANDUIT®* Cabling Systems are installed properly and 100% tested to verify compliance with EIA/TIA industry standards. In support of these objectives, systems installed by *PANDUIT®* Certified Installers are eligible for coverage under *PANDUIT®* CERTIFICATION PLUSSM Warranty Program.

PANDUIT® Certified Installers share our belief in providing high quality products and service. They have a BICSI RCDD or equivalent on staff, who understands structured cabling requirements to ensure a proper installation. In addition, theoretical and hands-on training is provided initially upon entrance into the PCI Program and repeated regularly to help *PANDUIT®* PCIs provide the best installation service in the industry.

The PCI Program provides high-end design and installation companies with the training and support required to install and maintain leading edge *PANDUIT®* Network Connectivity Solutions. What makes this program unique is the establishment of a global network of consistently trained, qualified organizations to help you quickly and efficiently deploy a network infrastructure you can trust to support your toughest applications.

PANDUIT® CERTIFIED DESIGNER PROGRAM





The *PANDUIT®* Network Connectivity Group offers the *PANDUIT®* Certified Designer (PCD) Program — an initiative designed to support the designer in providing high quality, state-of-the-art solutions in today's rapidly evolving communications market.

PANDUIT® aims to develop a responsive and collaborative relationship with the certified designer. By creating a relationship with our certified designers, we work together to specify best in-class cabling solutions for each unique infrastructure application.

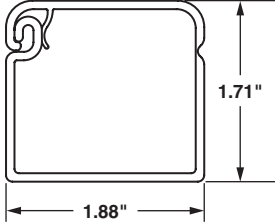
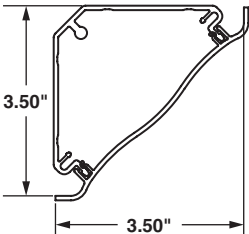
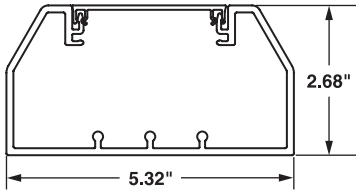
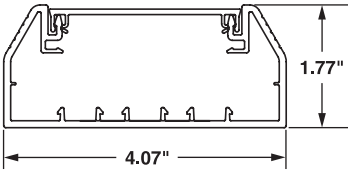
Specifying *PANDUIT®* products provides customers with a broad spectrum of integrated cabling components that meet and surpass diverse national and multinational requirements. Around the world, *PANDUIT®* leverages local expertise to customize our structured cabling solutions to the customer's needs.

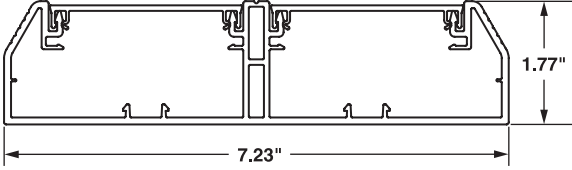
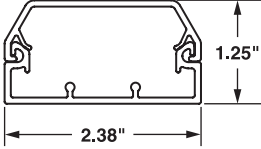
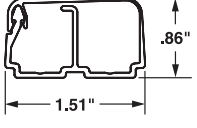
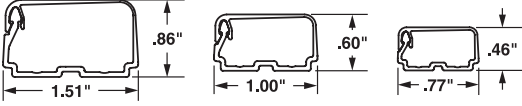
QUICK SELECTION GUIDE			
PANDUIT® Raceway System	Use	Key Feature	Page
<p>Office Furniture</p>  <p>Internal Area = 2.31 Sq. In.</p>	Data Only	<ul style="list-style-type: none"> Designed to route data cabling along the top of office furniture partitions to desktop termination Single channel raceway 	See pg. C1
<p>Cove</p>  <p>Internal Area = 5.40 Sq. In.</p>	Data and/or Power	<ul style="list-style-type: none"> Has the appearance of architectural molding and mounts high out of reach for increased tamper resistance Multi-channel raceway 	See pg. D1
<p>TG-70</p>  <p>Internal Area = 10.85 Sq. In.</p>	Data and/or Power	<ul style="list-style-type: none"> Large cable capacity Adjustable inside and outside corner fittings to adapt to non-square corners Accepts NEMA standard 70mm faceplates Multi-channel raceway 	See pg. E1
<p>T-70</p>  <p>Internal Area = 5.15 Sq. In.</p>	Data and/or Power	<ul style="list-style-type: none"> Low profile, aesthetically pleasing design and accepts NEMA standard 70mm faceplates Multi-channel raceway 	See pg. F1

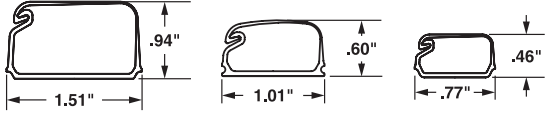
PANDUIT® RACEWAY SYSTEM	Use	Key Feature	Page
<p>Twin-70</p>  <p>Left Internal Area = 4.59 Sq. In. Right Internal Area = 4.59 Sq. In.</p>	<p>Data and/or Power</p>	<ul style="list-style-type: none"> Two independent channels and accepts NEMA standard 70mm faceplates Multi-channel raceway 	<p>See pg. F1</p>
<p>T-45</p>  <p>Internal Area = 2.12 Sq. In.</p>	<p>Data and/or Power</p>	<ul style="list-style-type: none"> Multi-directional cover hinge which allows installation from either side Multi-channel raceway 	<p>See pg. G1</p>
<p>LD2P10</p>  <p>Left Internal Area = .43 Sq. In. Right Internal Area = .50 Sq. In.</p>	<p>Data and/or Power</p>	<ul style="list-style-type: none"> Compact design for routing power and data in one drop Multi-channel raceway 	<p>See pg. K1</p>
<p>LDP</p>  <p>Internal Area = .96 Sq. In. Internal Area = .38 Sq. In. Internal Area = .21 Sq. In.</p>	<p>Data or Power</p>	<ul style="list-style-type: none"> One-piece hinged cover design and tamper resistant latch Single channel raceway 	<p>See pg. K1</p>
<p>LDS</p>  <p>Internal Area = .38 Sq. In. Internal Area = .21 Sq. In.</p>	<p>Data or Power</p>	<ul style="list-style-type: none"> One-piece single channel tamper resistant design for maximum security Single channel raceway 	<p>See pg. K1</p>
<p>LD</p>  <p>Internal Area = 1.00 Sq. In. Internal Area = .38 Sq. In. Internal Area = .21 Sq. In.</p>	<p>Data only</p>	<ul style="list-style-type: none"> One-piece single channel design for quick installation of data or low voltage cabling Single channel raceway 	<p>See pg. K1</p>

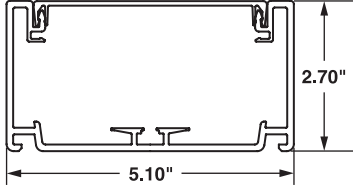
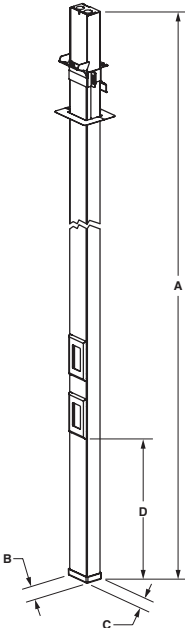
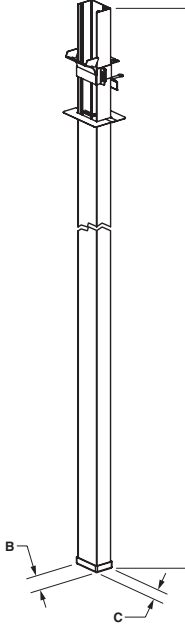
PANDUIT® RACEWAY SYSTEM	Use	Key Feature	Page
<p>T130</p>  <p>Internal Area = 10.96 Sq. In.</p>	<p>Data and/or Power</p>	<ul style="list-style-type: none"> Largest cable capacity of all PANDUIT® raceway 	<p>See pg. L1</p>
<p>PAN-POLE™ Power and Communication Pole</p>  <p>A = 11 ft. 2 In. or 13 ft. 2 In. B = 2.90 In. C = 1.77 In. D = 15.50 In.</p>	<p>Data and/or Power</p>	<ul style="list-style-type: none"> Dual channel which provides complete separations of power and data and allows for single drops in open areas 	<p>See pg. M1</p>
<p>PAN-POLE™ Communication Pole</p>  <p>A = 11 ft. 2 In. or 13 ft. 2 In. B = 2.90 In. C = 1.77 In.</p>	<p>Data Only</p>	<ul style="list-style-type: none"> Single channel provides routing of data or low voltage cabling in open areas 	<p>See pg. M1</p>

System
Overview

Quick
Selection
Guide

Office
Furniture

Cove

TG-70

T-70
&
Twin-70

T-45

Ultimate
ID
System

Faceplates,
Boxes &
Labeling

LD Profile

T130

Outlet
Pole

Technical
Info

Index

PANDUIT[®]

NON-METALLIC SURFACE RACEWAY

NOTES

PAN-WAY® OFFICE FURNITURE NON-METALLIC SURFACE RACEWAY

PAN-WAY® Office Furniture Raceway is a one-piece single channel system designed to route data cabling along the top of office furniture partitions. The system includes a full complement of fittings, accessories, and termination options which allows positioning of outlets at any point along the partition at desk level or in the corner at the intersection of two partitions. Office Furniture Raceway has a tamper resistant closure design which protects sensitive cabling from accidental damage and discourages unauthorized access, yet the system is accessible by a qualified installer for moves, adds and changes.



- Designed for desktop terminations which utilize the typically unused area of the cubicle
- Fittings meet the TIA/EIA bend radius requirements preventing cable performance degradation, yet maintain original aesthetic "squared corner" styling of furniture
- Designed to work with major office furniture manufacturers panels (such as Steelcase, Herman Miller and others) to create a virtually invisible solution for routing data cabling
- Robust design includes a one-piece hinge and tamper resistant closure design which increases product stability and reduces inadvertent or unauthorized access to data cabling
- Designed for use with PAN-NET® Connectivity. Also accepts all common manufacturers' connectivity with use of a NEMA standard 70mm faceplate or module frame

PANDUIT® Office Furniture Raceway is available in three popular colors to blend with most office furniture systems and creates a virtually invisible cost effective routing solution.

Office Furniture Raceway Roadmap

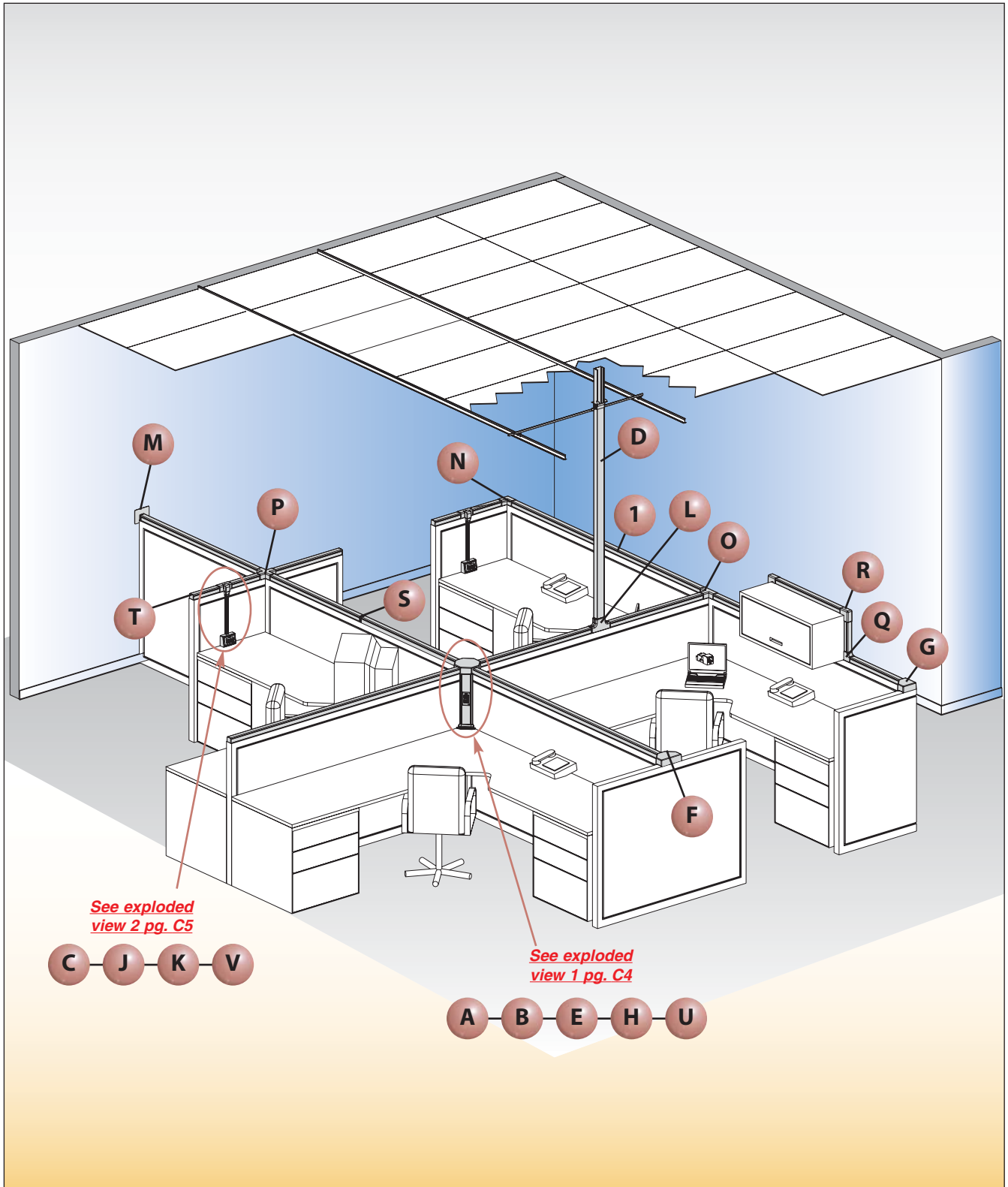

See exploded view 2 pg. C5

See exploded view 1 pg. C4

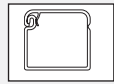

1 ***OFR20**6 — Office Furniture Raceway Base and Cover (page C6)***

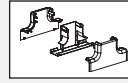

L ***OFR20MPT** — Mid Panel Tee Fitting (page C7)***

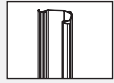

A ***OF70**6 — Corner Raceway Base (page C6)***



M ***OFR20WE** — Wall Entrance Fitting (page C7)***

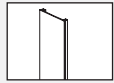

B ***OFCRC70**6 — Corner Raceway Cover (page C6)***

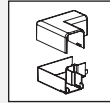

N ***OFR20RA** — Right Angle Fitting (page C8)***

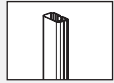

C ***OFVR5**6 — Vertical Raceway (page C6)***

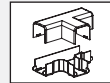

O ***OFR20T** — Tee Fitting (page C8)***

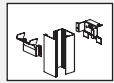

D ***OFR20CP**8 — Communication Pole (page C6)***

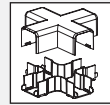

P ***OFR20CR** — Cross Fitting (page C8)***

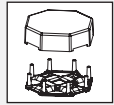

E ***OFR20OFCR70**4 — Four Cubicle Drop Fitting (page C7)***

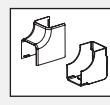

Q ***OFR20IC** — Inside Corner Fitting (page C8)***

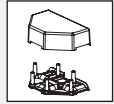

F ***OFR20OFCR70**2 — Two Cubicle Drop Fitting (page C7)***

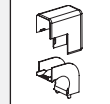

R ***OFR20OC** — Outside Corner Fitting (page C8)***

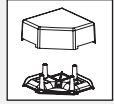

G ***OFR20OFCR70**1 — One Cubicle Drop Fitting (page C7)***



S ***OFR20CC** — Coupler Fitting (page C8)***



H ***OF70**EC** — End Cap Fitting (page C7)***

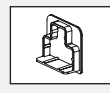

T ***OFR20EC** — End Cap Fitting (page C8)***

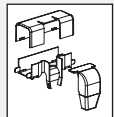

J ***OFR20SO** — Spill Over Fitting (page C7)***

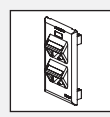

U ***OF70FV4** — Vertical Sloped Communication Snap-On Faceplate (page C8)***

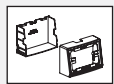

K ***OFR20DMB** — Desk Mount Box (page C7)***

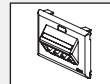

V ***OF70FH4** — Horizontal Sloped Communication Snap-On Faceplate (page C8)***

Office Furniture Configurations

Exploded view 1

	Components Required	See page
A.	OFR20OFCR70**4 = Four Cubicle Drop Fitting.	C7
B.	OFCR70**6 = Corner Raceway Base.	C6
C.	OFCR70EC = End Cap Fitting.	C7
D.	OF70FV4 = Vertical Sloped Communication Snap-on Faceplate.	C8
E.	PAN-NET® Connectivity.	—
F.	OFCRC70**6 = Corner Raceway Cover.	C6

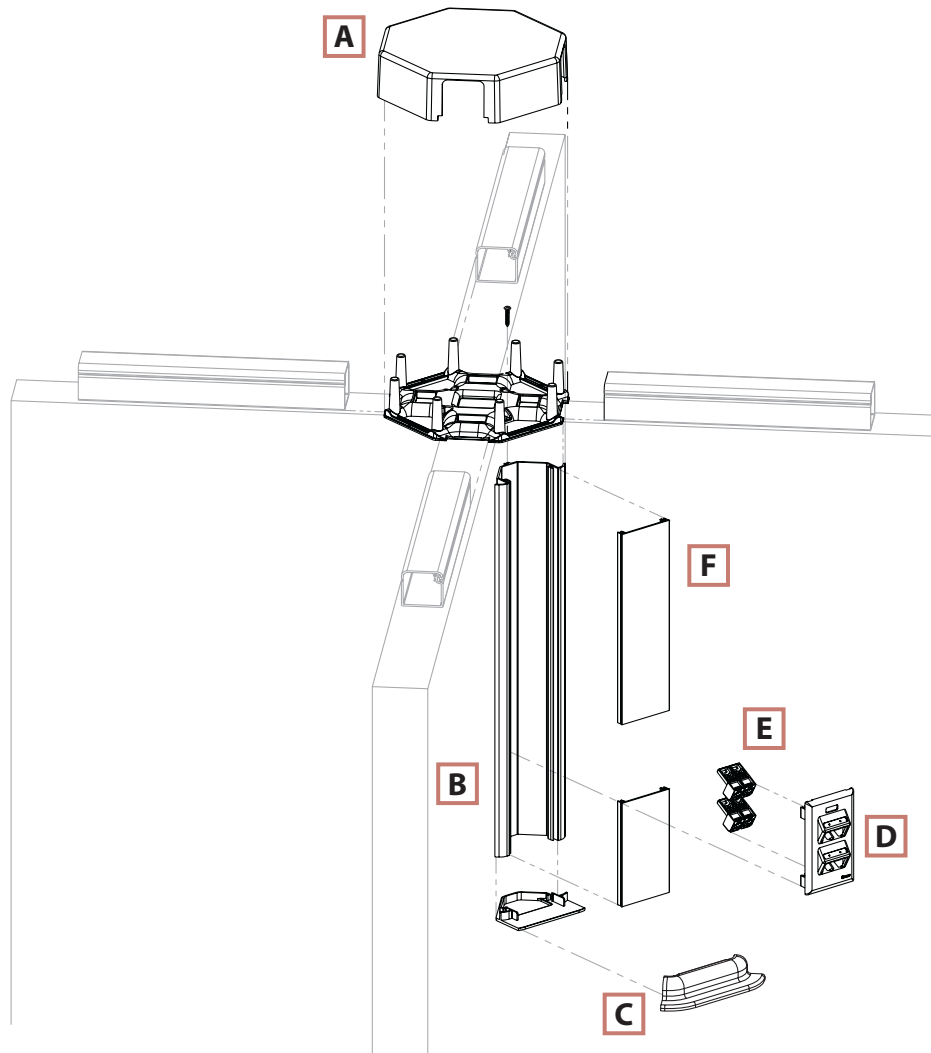

Office Furniture Configurations

Exploded view 2

	Components Required	See page
A.	OFR20SO** = Spill Over Fitting.	C7
B.	OFVR5**6 = Vertical Raceway.	C6
C.	OFR20DMB = Desk Mount Box.	C7
D.	PAN-NET® Connectivity.	—
E.	OF70FH4** = Horizontal Sloped Communication Snap-on Faceplate.	C8

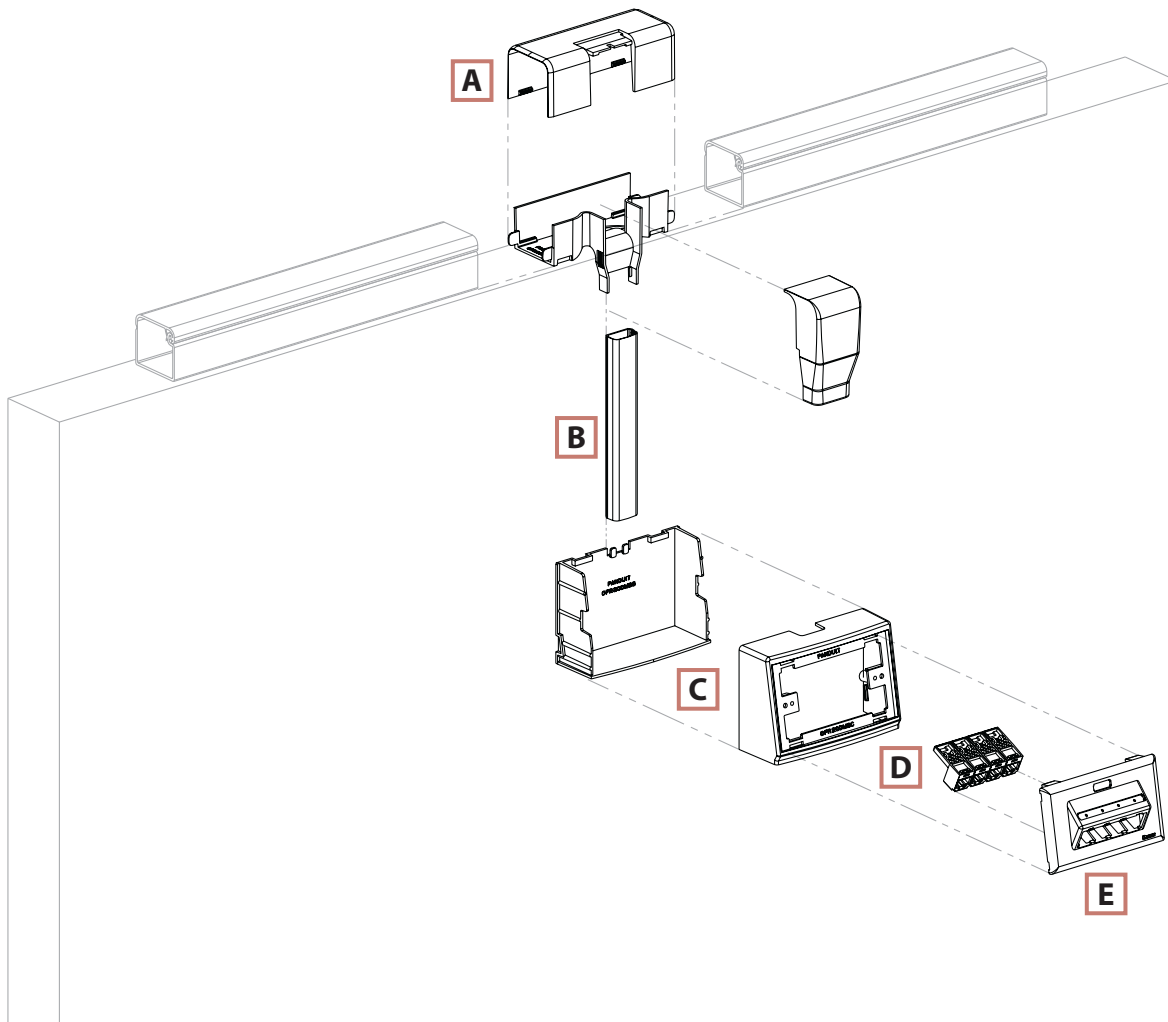



PAN-WAY® Office Furniture Raceway System

- UL listed in accordance with UL-5C requirements for Class 2 Communication Cable Management Systems
- Maintains bend radius control throughout the entire Office Furniture Raceway system as required by TIA/EIA 568-B and 569-B
- Faceplates are compliant with the labeling requirements of the TIA/EIA-606-A standard
- Robust design and tamper resistant closure increases product stability and prevents damage to cabling during and after installation
- Product supplied with adhesive backing for fast and easy installation
- Creates a virtually invisible solution for routing data cables on panels from all common manufacturers with a top cap width between 1.88" and 2.30"

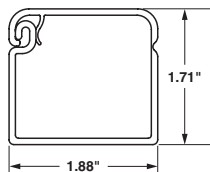

Internal Area = 2.31 Sq. In.



Office Beige (OB)

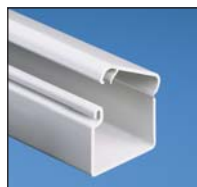

Office Gray (OG)



Office Slate (OS)



OFR20

Part Number	Part Description	Raceway Size	Color‡	Length (ft)	Std. Pkg. Qty.	Std. Ctn. Qty.
OFR20OB6	Office Furniture Raceway. One piece single channel low voltage raceway with adhesive tape backing for data cable routing along top of modular furniture partitions. Available in 6' lengths.	1.88" x 1.71"	Office Beige	6'	6	48

‡ For other colors, replace OB (Office Beige) with OS (Office Slate) or OG (Office Gray).
Order number of feet required in multiples of standard carton quantity.



PAN-WAY® Office Furniture Raceway Fittings

- Office Furniture Raceway fittings have been designed to maintain the TIA/EIA required 1" minimum bend radius for high performance copper and fiber optic cabling systems



OFCR70



OFCRC70



OFVR5



OFR20CP

Part Number	Part Description	Labels Required	Color‡	Std. Pkg. Qty.	Std. Ctn. Qty.
OFCR70OB6	Office Furniture Corner Raceway Base. Used to terminate low voltage data cabling in the corner at the intersection of modular office furniture panels. Accepts 70mm standard faceplates. Available in 6' lengths.	—	Office Beige	6	48
OFCRC70OB6	Office Furniture Corner Raceway Cover. Available in 6' lengths.	—	Office Beige	6	48
OFVR5OB6	Office Furniture Vertical Raceway. One piece single channel raceway used to connect OFR20**6 to desk mount box (OFR20DMB**) and must be used with OFR20SO**. Available in 6' lengths.	—	Office Beige	6	120
OFR20CPOB8	Communication Pole. Allows for data cable entry into Office Furniture Raceway from suspended ceiling. 8' pole allows maximum 7" distance from top of furniture partition to ceiling. Must be used with OFR20MPT**. NOTE: Not intended for use at intersection of furniture panels.	—	Office Beige	1	—

‡ For other colors, replace OB (Office Beige) with OS (Office Slate) or OG (Office Gray).



PAN-WAY® Office Furniture Raceway Fittings (Continued)



OFR20OFCR70**4



OFR20OFCR70**2



OFR20OFCR70**1



OFRCR70EC



OFR20SO



OFR20DMB



OFR20MPT



OFR20WE

Part Number	Part Description	Labels Required	Color‡	Std. Pkg. Qty.	Std. Ctn. Qty.
OFR20OFCR70OB4	Four Cubicle Drop Fitting. Allows the transition from Office Furniture Raceway run horizontally along partition wall to Office Furniture Corner Raceway mounted vertically in four cubicles at the intersection of partitions. Fitting maintains 1" minimum bend radius of cabling. Supplied with adhesive tape.	—	Office Beige	1	10
OFR20OFCR70OB2	Two Cubicle Drop Fitting. Allows the transition from Office Furniture Raceway run horizontally along partition wall to Office Furniture Corner Raceway mounted vertically in two cubicles at the intersection of partitions. Fitting maintains 1" minimum bend radius of cabling. Supplied with adhesive tape.	—	Office Beige	1	10
OFR20OFCR70OB1	One Cubicle Drop Fitting. Allows the transition from Office Furniture Raceway run horizontally along partition wall to Office Furniture Corner Raceway mounted vertically in one cubicle at the intersection of partitions. Fitting maintains 1" minimum bend radius of cabling. Supplied with adhesive tape.	—	Office Beige	1	10
OFCR70ECOB	Corner Raceway End Cap Fitting. Opening allows cord passage through fitting such as monitor and keyboard cables. Supplied with adhesive tape.	—	Office Beige	1	10
OFR20SOOB	Spill-over Fitting. Allows transition from Office Furniture Raceway run horizontally along partition wall to Office Furniture Vertical Raceway in one location. Adjustable fitting maintains 1" minimum bend radius of cabling and works with various panel widths between 1.88"-2.30". Supplied with adhesive tape.	—	Office Beige	1	10
OFR20DMBOB	Desk Mount Box. Box accepts Office Furniture Snap-on Faceplates as well as 70mm NEMA standard screw-on faceplates. Designed for use with OFVR5**6 raceway and OFR20SO** spill over fitting. Supplied with adhesive tape.	—	Office Beige	1	10
OFR20MPTOB	Mid-panel Tee Fitting. Used to connect communication pole to Office Furniture Raceway run horizontally along partition wall. Supplied with adhesive tape. NOTE: Not intended for use at intersection of furniture panels.	—	Office Beige	1	10
OFR20WEOB	Wall Entrance Fitting. Allows entry from wall to Office Furniture Raceway run horizontally along partition walls. Fitting includes bend radius protection and trim plate to cover wall opening. Requires minimum wall opening of 4.5"W x 3.0"H. Supplied with adhesive tape.	—	Office Beige	1	10

‡ For other colors, replace OB (Office Beige) with OS (Office Slate) or OG (Office Gray).

System Overview

Quick Selection Guide

Office Furniture

Cove

TG-70

T-70 & Twin-70

T-45

Ultimate ID System

Faceplates, Boxes & Labeling

LD Profile

T130

Outlet Pole

Technical Info

Index



PAN-WAY® Office Furniture Raceway Fittings (Continued)



OFR20RA



OFR20T

Part Number	Part Description	Labels Required	Color‡	Std. Pkg. Qty.	Std. Ctn. Qty.
OFR20RAOB	Right Angle Fitting. Used to join sections of Office Furniture Raceway at 90° flat junction. Supplied with adhesive tape.	—	Office Beige	1	10
OFR20TOB	Tee Fitting. Used to create an undivided tee junction between sections of Office Furniture Raceway. Supplied with adhesive tape.	—	Office Beige	1	10
OFR20CROB	Cross Fitting. Used to join sections of Office Furniture Raceway at four corners. Supplied with adhesive tape.	—	Office Beige	1	10
OFR20ICOB	Inside Corner Fitting. Used to join sections of Office Furniture Raceway at inside corner. Supplied with adhesive tape.	—	Office Beige	1	10
OFR20OCOB	Outside Corner Fitting. Used to join sections of Office Furniture Raceway at outside corner. Supplied with adhesive tape.	—	Office Beige	1	10
OFR20CCOB-X	Coupler Fitting. For use with Office Furniture Raceway.	—	Office Beige	10	100
OFR20ECOB	End Cap Fitting. Used to terminate Office Furniture Raceway. Supplied with adhesive tape.	—	Office Beige	1	10
OF70FH2OB*	Snap-on Single Gang Horizontal Sloped Communication Faceplate. Accepts up to two <i>MINI-COM</i> ® modules (not included). No additional mounting hardware required. TIA/EIA-606-A compliant.	1-One Port 1-Two Port	Office Beige	1	10
OF70FV2OB*	Snap-on Single Gang Vertical Sloped Communication Faceplate. Accepts up to two <i>MINI-COM</i> ® modules (not included). No additional mounting hardware required. TIA/EIA-606-A compliant.	1-One Port 1-Two Port	Office Beige	1	10
OF70FH4OB*	Snap-on Single Gang Horizontal Sloped Communication Faceplate. Accepts up to four <i>MINI-COM</i> ® modules (not included). No additional mounting hardware required. TIA/EIA-606-A compliant.	1-One Port 1-Four Port	Office Beige	1	10
OF70FV4OB*	Snap-on Single Gang Vertical Sloped Communication Faceplate. Accepts up to four <i>MINI-COM</i> ® modules (not included). No additional mounting hardware required. TIA/EIA-606-A compliant.	1-One Port 2-Two Port	Office Beige	1	10
T70SDB-X	Standard Faceplate Bracket. Used to mount NEMA standard 70mm single gang screw-on electrical/communication faceplates only.	—	Gray	10	100

‡ For other colors, replace OB (Office Beige) with OS (Office Slate) or OG (Office Gray).

* Can be clearly identified with labels, [reference chart on page C9](#).

For complete labeling solutions and product information, [reference chart on page J17](#).

Component Labels for Office Furniture Raceway Faceplates

Suggested Label Solutions for TIA/EIA-606-A Compliance			
Faceplate Part Number	Laser/Ink Jet Desktop Printer Label	VIPER™ LS6 Portable Printer Label	PANACEA® LS7 Hand-held Printer Label
OF70FH2	C061X030FJJ C125X030FJJ	C061X030FJ6 C125X030FJ6	LS7-25-1
OF70FV2	C061X030FJJ C125X030FJJ	C061X030FJ6 C125X030FJ6	LS7-25-1
OF70FH4	C061X030FJJ C125X030FJJ	C061X030FJ6 C252X030FJ6	LS7-25-1
OF70FV4	C061X030FJJ 2-C125X030FJJ	C061X030FJ6 2-C125X030FJ6	LS7-25-1

For complete labeling solutions and product information, [reference chart on page J17](#).

Quick Wire Fill Capacities for Office Furniture Raceway

This information is to be used as a guide in selecting the proper size raceway. The maximum amounts may vary according to the wire installation methods, straightness of wires, etc.

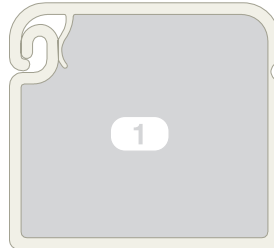

$$A = 2.30 \text{ in}^2$$

Wirefill #1: Open Channel without Devices

SPEC = 40% wire fill — The recommended design in cable capacity, leaves room for future moves, adds and changes.

MAX for Data = 60% wire fill — The maximum cable quantity based on cable interweaving and packing factors.

MAX for Power — The maximum of electrical cables based on UL temperature rise test.

Raceway Type & Configuration	Fill Area (in ²)	Data Grade Cable		Data Grade Cable		Coax Cable		Fiber Optic Cable	
		24 AWG/UTP CM		24 AWG/UTP CM		RG6		2 Strand	
		Cat 5e (4pr)		Cat 6 (4pr)		DIA. = .275		DIA. = .175	
		DIA. = .217		DIA. = .250					
		FILL		FILL		FILL		FILL	
		SPEC (40%)	MAX (60%)	SPEC (40%)	MAX (60%)	SPEC (40%)	MAX (60%)	SPEC (40%)	MAX (60%)
1. OFR20: No Devices.	2.30	24	37	18	28	15	23	38	57

PAN-WAY® COVE NON-METALLIC SURFACE RACEWAY

PAN-WAY® Cove Raceway is a full line of NEC and TIA/EIA compliant raceway which has the appearance of architectural molding; yet allows you to route, conceal, protect, and terminate data, voice, video, fiber optic, or power cabling. This offering adds elegance to any room or work area by softening the horizontal angles between the wall and ceiling or the vertical angles between two walls.



- UL & CSA rated to 600V
- Bend radius control is maintained throughout the entire Cove Raceway System as required by TIA/EIA-568-B and 569-B
- Product mounts high out of reach for increased tamper resistance
- Divided channel system allows for routing and termination of both power and data cabling
- Raceway and fitting covers may be painted to match any decor

PANDUIT® Cove Raceway creates a unique architectural style and transitions easily to other PANDUIT® Raceway such as: LD, LDP, LD2P10, T-45 and T-70.

System
Overview

Quick
Select
Guide

Office
Furniture

Cove

TG-70

T-70
&
Twin-70

T-45

Ultimate
ID
System

Faceplates,
Boxes &
Labeling

LD Profile

T130

Outlet
Pole

Technical
Info

Index

Cove Raceway Roadmap

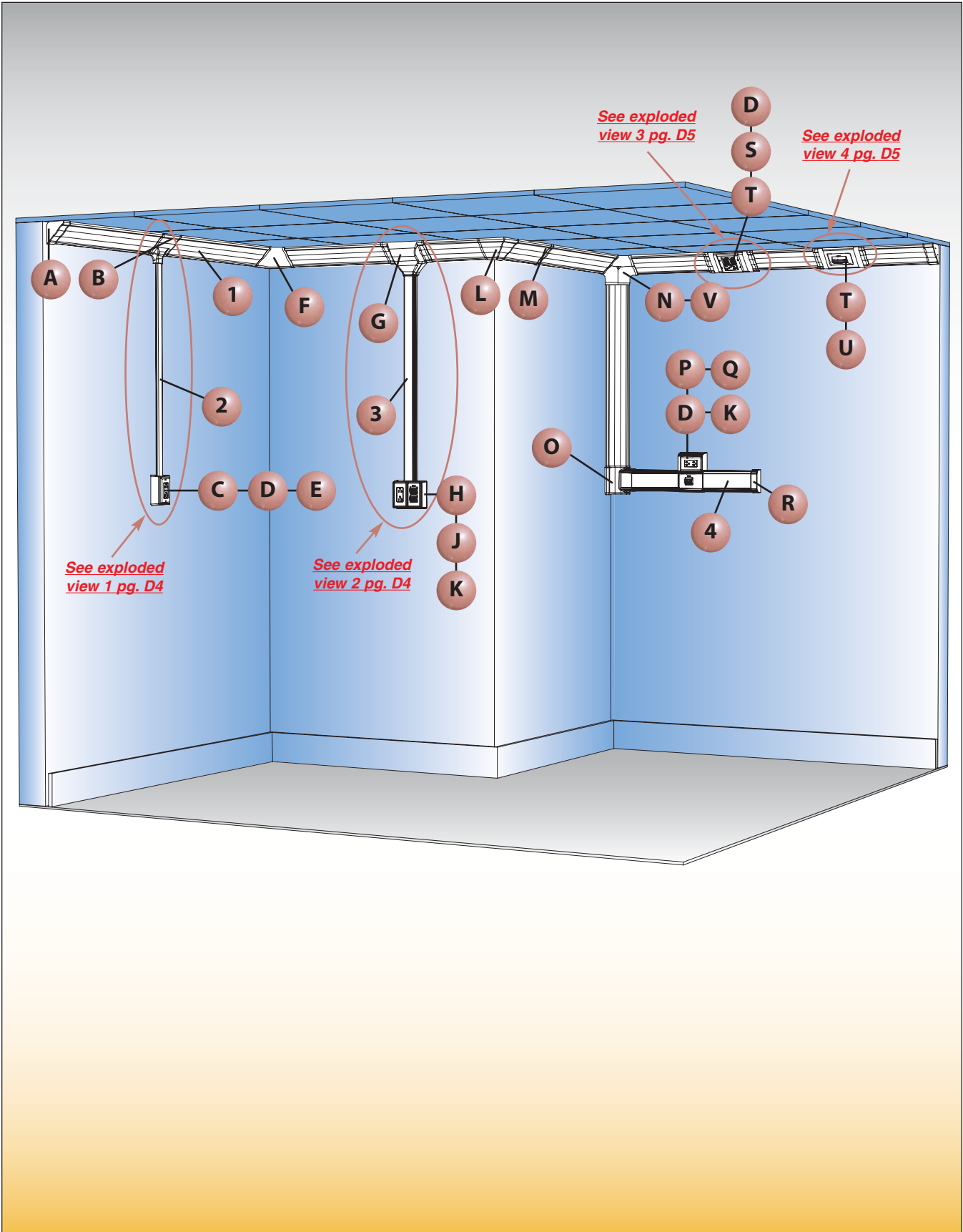

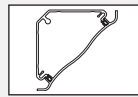

1 ***WCM35BIW, WCM35CIW — Cove Raceway Base and Cover (page D6)***

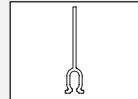

1 ***WCM35DW — Cove Raceway Divider Wall (page D6)***



2 ***LDP10** — LDP10 Raceway (page K15)***

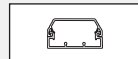

3 ***T45B**, T45C** — T-45 Raceway Base and Cover (page G6)***

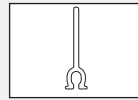

3 ***T45DW — T-45 Raceway Divider Wall (page G6)***

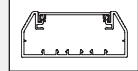

4 ***T70B**, T70C** — T-70 Raceway Base and Cover (page F8)***

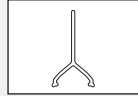

4 ***T70DW — T-70 Raceway Divider Wall (page F8)***

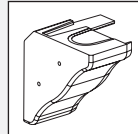

A ***WCM35ECIW — Cove Raceway End Cap (page D7)***

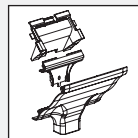

B ***WCM35TR10IW — Cove Raceway Low Profile Transition Fitting for LD/LDP10 Raceway (page D7)***

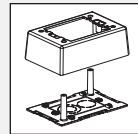

C ***JBP1** — Power Rated Single Gang Two-Piece Box (page J8)***

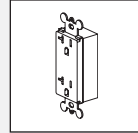

D ***EUR20** — 20A Rectangular Outlet (page J11)***

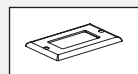

E ***CPG** — Single Gang Rectangular Electrical/Communication Snap-On Faceplate (page J10)***

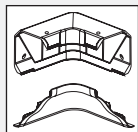

F ***WCM35ICIW — Cove Raceway Inside Corner Fitting (page D7)***



G ***WCM35TRIW — Cove Raceway Transition Fitting for T-45 and LD Series Raceways (page D7)***

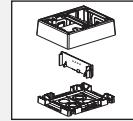

H ***JBP2FS** — FAST-SNAP™ Double Gang Power Rated Surface Mount Outlet Box (page J2)***

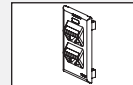

J ***UIT70FV4** — ULTIMATE ID™ Sloped Vertical Snap-On Faceplate (page H5)***

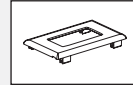

K ***T70PG — Single Gang Rectangular Electrical/Communication Snap-On Faceplate (page J3)***

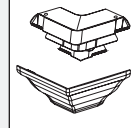

L ***WCM35OCIW — Cove Raceway Outside Corner Fitting (page D7)***



M ***WCM35CCIW — Cove Raceway Cover Coupler Fitting (page D7)***

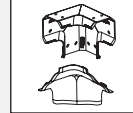

N ***WCM35TIW — Cove Raceway Tee Fitting (page D7)***

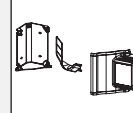

O ***WCM35TR70 — Cove Raceway Low Profile Transition Fitting for T-70 Raceway (page D7)***



P ***T70WC2** — T-70 WORKSTATION OUTLET CENTER™ Offset Box for Snap-On Faceplates (page F9)***

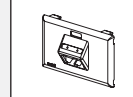

Q ***UIT70FH2** — ULTIMATE ID™ Horizontal Snap-On Faceplate (page H5)***



R ***T70EC — T70 Raceway End Cap Fitting (page F9)***

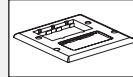

S ***FP2RC — Double Gang Rectangular Electrical and Communication Faceplate (page J10)***

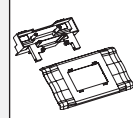

T ***WCM35DBF — Cove Raceway Device Box and Faceplate Adapter (page D7)***

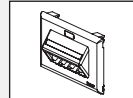

U ***UIT70FH4** — ULTIMATE ID™ Horizontal Snap-On Faceplate (page H5)***

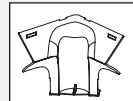

V ***WCM35TI — Cove Raceway Tee Fitting Insert (page D7)***

Cove Configurations

Exploded view 1

	Components Required	See page
A.	WCM35TR10 = Cove Raceway Low Profile Transition Fitting for LD/LDP10 Raceway.	D7
B.	JBP1 = Power Rated Single Gang Two-Piece Box.	J8
C.	ERU20 = 20A Rectangular Electrical Outlet (screws included).	J11
D.	CPG = Screw-On Single Gang Rectangular Faceplate.	J10

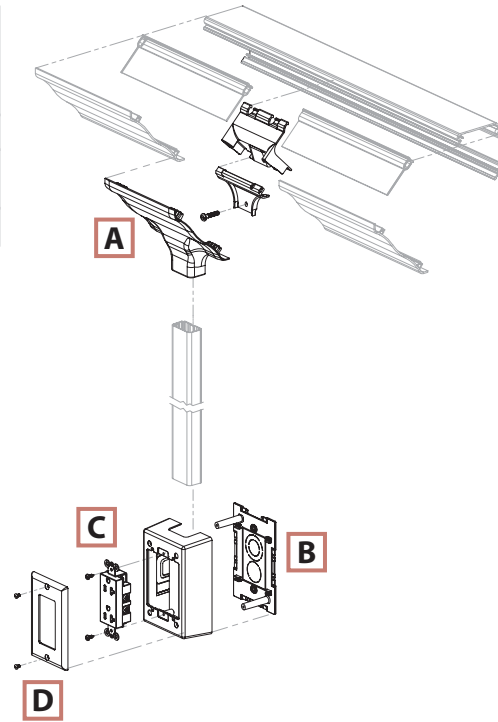

Exploded view 2

	Components Required	See page
A.	WCM35TR = Cove Raceway Transition Fitting.	D7
B.	JBP2FS = <i>FAST-SNAP</i> ™ Double Gang Power Rated Surface Mount Outlet Box.	J2
C.	<i>PAN-NET</i> ™ Connectivity.	—
D.	T70PG = Single Gang Rectangular Electrical/Communication Snap-On Faceplate.	J3
E.	UIT70FV4 = <i>ULTIMATE ID</i> ™ Sloped Vertical Snap-On Faceplate.	H5
F.	ERU20 = 20A Rectangular Electrical Outlet (screws included).	J11

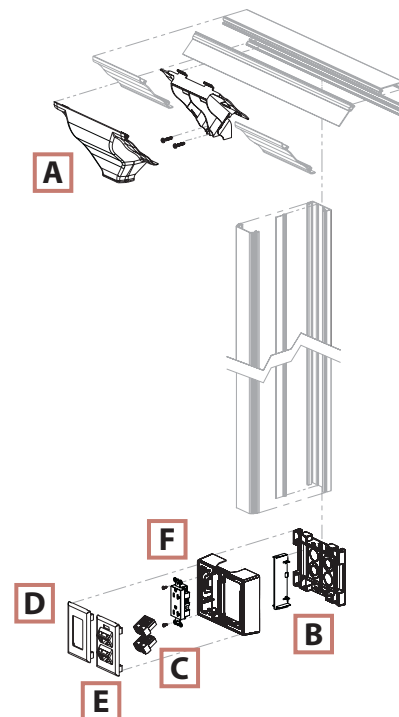

Cove Configurations (Continued)

Exploded view 3

	Components Required	See page
A.	WCM35DBF = Cove Raceway Device Box and Faceplate Adapter.	D7
B.	FP2RC = PAN-WAY® Classic Series Faceplates for Power and Communication.	J10
C.	PAN-NET® Connectivity.	—
D.	ERU20 = 20A Rectangular Electrical Outlet (screws included).	J11

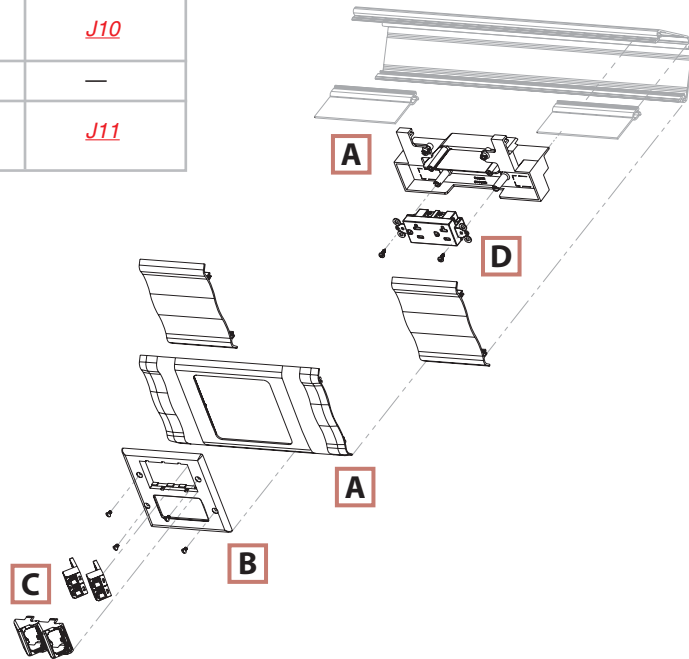

Exploded view 4

	Components Required	See page
A.	WCM35DBF = Cove Raceway Device Box and Faceplate Adapter.	D7
B.	PAN-NET® Connectivity.	—
C.	UIT70FH4 = ULTIMATE ID™ Horizontal Snap-On Faceplate.	H5

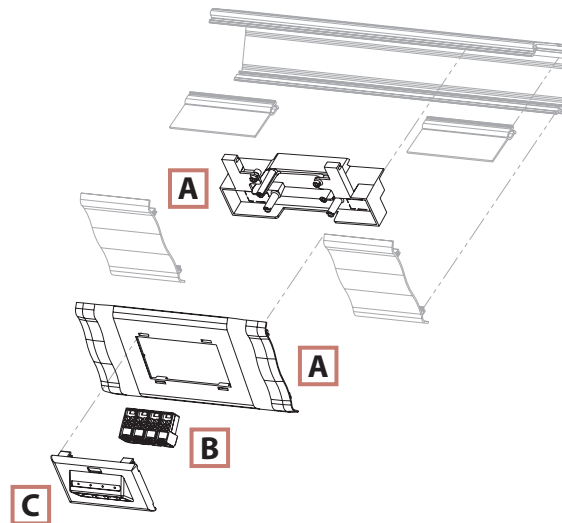

PANDUIT®

NON-METALLIC SURFACE RACEWAY

UL® SP® SA LISTED PAN-WAY® Cove Raceway System

- UL & CSA rated 600V; meets UL5A and CSA C22.2 No. 62.1-03 standards
- Bend radius control is maintained throughout the entire Cove Raceway System as required by TIA/EIA 568-B and 569-B
- Tamper resistant
- Transitions to *PANDUIT®* T-70, T-45, and LD Profile Raceways
- Cove raceway and fittings may be painted to blend with any decor
- Supplied with pre-punched mounting holes

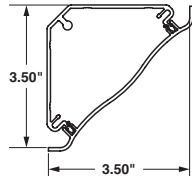

Internal Area = 5.40 Sq. In.



WCM35BIW8



WCM35CIW8



WCM35DW8

Part Number	Part Description	Raceway Size	Color‡	Length (ft)	Std. Ctn. Qty.
Cove Raceway Base					
WCM35BIW8	Cove Raceway Base is available in 8' lengths and is used for mounting in the horizontal corner between the ceiling and wall or vertical corner between walls.	3.50" x 3.50"	Off White	8'	64
Cove Raceway Cover					
WCM35CIW8	Cove Raceway Cover available in 8' lengths.	–	Off White	8'	64
Cove Raceway Divider Wall					
WCM35DW8	Cove Raceway Divider Wall. Snaps onto rails in Cove Raceway Base to create separate channels. Must use wire retainers to ensure channel separation per UL/CSA. Available in 8' lengths.	–	Gray	8'	64

‡ All parts available in IW (Off White) only except for WCM35DW8 which is available in Gray only.
Order number of feet required in multiples of standard carton quantity.
Order raceway base and cover separately.

UL SA LISTED SP PAN-WAY® Cove Raceway Fittings

- Cove Raceway fittings are designed to maintain the TIA/EIA 568-B and 569-B required minimum bend radius for high performance copper and fiber optic cabling systems



WCM35CCIW-X

WCM35ICIW

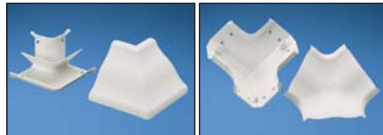

WCM35OCIW

WCM35TIW

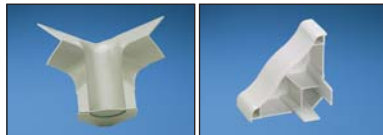

WCM35TI

WCM35ECIW



WCM35TRIW

WCM35TR5IW

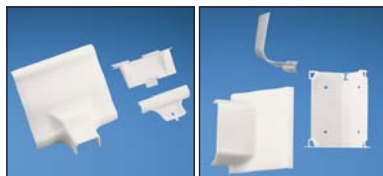

WCM35TR10IW

WCM35TR70IW

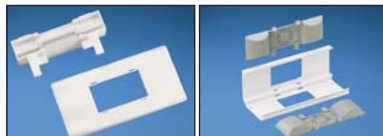

WCM35DBFIW

WCM35BFIW

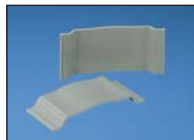

WCM35WR-X

Part Number	Part Description	Color‡	Std. Pkg. Qty.	Std. Ctn. Qty.
WCM35CCIW-X	Cover Coupler Fittings. Used to join two pieces of Cove Raceway Cover together.	Off White	10	100
WCM35ICIW	Inside Corner Fitting. Used to join Cove Raceway at inside corners. Maintains a minimum 1" bend radius of cabling.	Off White	1	10
WCM35OCIW	Outside Corner Fitting. Used to join Cove Raceway at outside corners. Maintains a minimum 1" bend radius of cabling.	Off White	1	10
WCM35TIW	Tee Fitting. Used to join sections of Cove Raceway to form a "tee" junction. Maintains a minimum 1" bend radius of cabling.	Off White	1	10
WCM35TI	Tee Fitting Insert. Mounts inside Cove Raceway tee fitting to maintain channel separation at tee junctions. Maintains a minimum 1" bend radius of cabling.	Gray	1	10
WCM35ECIW	End Cap Fitting. Used to terminate or enter Cove Raceway. Includes breakouts for 1/2" and 3/4" conduit.	Off White	1	10
WCM35TRIW	Transition Fitting. Used to transition from Cove Raceway to PAN-WAY® T-45 Raceway and LD Profile Raceway.	Off White	1	10
WCM35TR5IW	Low Profile Transition Fitting. Used to transition from Cove Raceway to LD / LDP5.	Off White	1	10
WCM35TR10IW	Low Profile Transition Fitting. Used to transition from Cove Raceway to LD / LDP10.	Off White	1	10
WCM35TR70IW	Low Profile Transition Fitting. Used to transition from Cove Raceway to T-70.	Off White	1	10
WCM35DBFIW	Device Box and Faceplate Adapter. Used in Cove Raceway to install single or double gang power and/or data devices in-line. Will accept snap-on or screw-on single gang faceplate or screw-on double gang faceplate. <i>NOTE:</i> Will accept GFCI or TVSS outlets in single gang configuration only.	Off White	1	10
WCM35BFIW	Backfeed Fitting. Inserts allow cable entry and exit through the back of the raceway and conduit. Breakouts include 1/2", 3/4" and 1".	Off White	1	10
WCM35WR-X	Wire Retainers. Holds wires in place. Will not interfere with cover installation.	Gray	10	100

‡ All parts available in IW (Off White) only except WCM35WR-X and WCM35TI which are available in Gray only.

Quick Wire Fill Capacities for Cove Raceway

This information is to be used as a guide in selecting the proper size raceway. The maximum amounts may vary according to the wire installation methods, straightness of wires, etc.

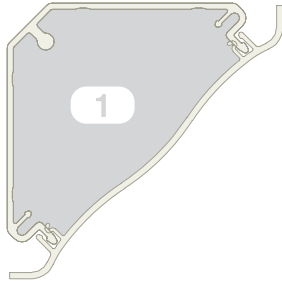

A = 5.4 in²

Wirefill #1: Open channel without Devices.

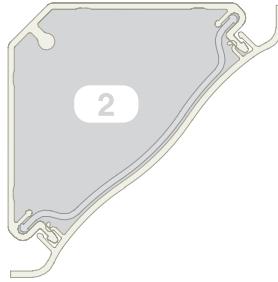

A = 5.0 in²

Wirefill #2: Open channel with Wire Retainer.

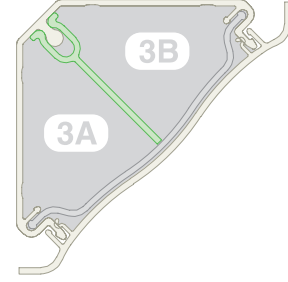

3A = 2.4 in² 3B = 2.4 in²

Wirefill #3: Divided channel (power and data) with Wire Retainer and Divider Wall.

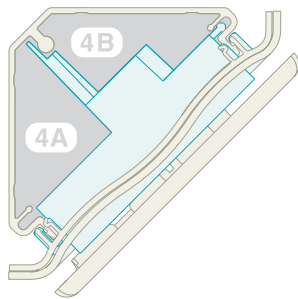

A = 1.6 in²

A = 1.4 in²

Wirefill #4: Divided Channel (power and data) with Device Box and Faceplate.

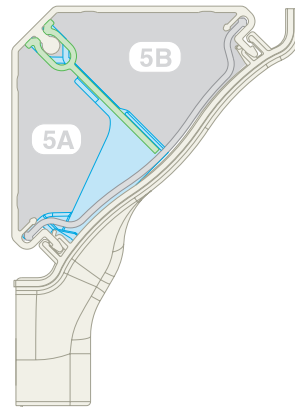

A = 1.8 in²

A = 2.4 in²

Wirefill #5: Divided Channel (power and data) with Low Profile Transition Insert.

SPEC = 40% wire fill — The recommended design in cable capacity, leaves room for future moves, adds, and changes.

MAX for Data = 60% wire fill — The maximum cable quantity based on cable interweaving and packing factors.

MAX for Power — The maximum of electrical cables based on UL temperature rise test.

Raceway Type & Configuration	Fill Area (in ²)	Electrical Cables			Data Grade Cable		Data Grade Cable		Coax Cable		Fiber Optic Cable	
		14 AWG	12 AWG	10 AWG	24 AWG/UTP CM	24 AWG/UTP CM	RG6		2 Strand			
		THHN/T90			Cat 5e (4pr)		Cat 6 (4pr)		DIA. = .275		DIA. = .175	
		.105	.122	.153	DIA. = .217		DIA. = .250					
		FILL	FILL	FILL	FILL	FILL	FILL	FILL	FILL	FILL	FILL	
		MAX (UL Temp Rise Test)	MAX (UL Temp Rise Test)	MAX (UL Temp Rise Test)	SPEC (40%)	MAX (60%)	SPEC (40%)	MAX (60%)	SPEC (40%)	MAX (60%)	SPEC (40%)	MAX (60%)
1. WCM35: No Devices.	5.4	50	40	30	58	87	44	66	29	43	89	134
2. WCM35: Using Wire Retainer – No Devices.	5	50	40	30	54	81	41	61	26	40	83	124
3A. WCM35: Power and data using Wire Retainer and Divider Wall.	2.4	—	—	—	25	38	19	28	13	19	39	58
3B.	2.4	30	25	20	—	—	—	—	13	19	22	—
4A. WCM35: Power and data using DBF.	1.6	—	—	—	17	25	13	19	10	16	26	35
4B.	1.4	25	25	20	—	—	—	—	—	—	—	—
5A. WCM35: Power and data using Low Profile Transition Insert.	1.8	25	25	20	19	29	14	22	12	18	29	44
5B.	2.5	—	—	—	25	38	19	28	13	19	39	58

PAN-WAY® TG-70 Non-Metallic Surface Raceway

PAN-WAY® TG-70 Non-Metallic Surface Raceway is a multi-channel raceway which provides a solution for routing low voltage, fiber optic, and/or power cabling when maximum cable capacity is required. The TG-70 Raceway System consists of raceway base, cover, fittings, termination hardware and accessories.

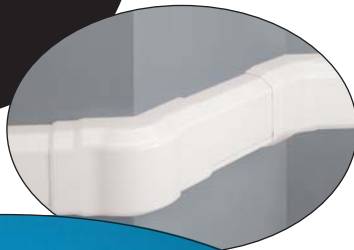
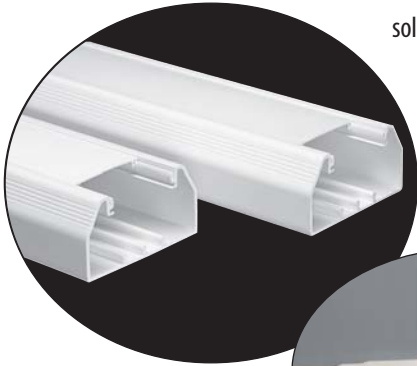

- Large raceway channel provides maximum capacity
- Fittings maintain 40mm (1.6") bend radius control
- Multi-channel two-piece design
- Aesthetically pleasing
- Lightweight
- Tamper resistant

PANDUIT® TG-70 Raceway can mount NEMA standard screw-on faceplates or superior PAN-WAY® Snap-on Faceplates directly to the channel. Fittings for TG-70 are available to transition to PAN-WAY® T-45 and LD Raceway.

TG-70 Raceway Roadmap

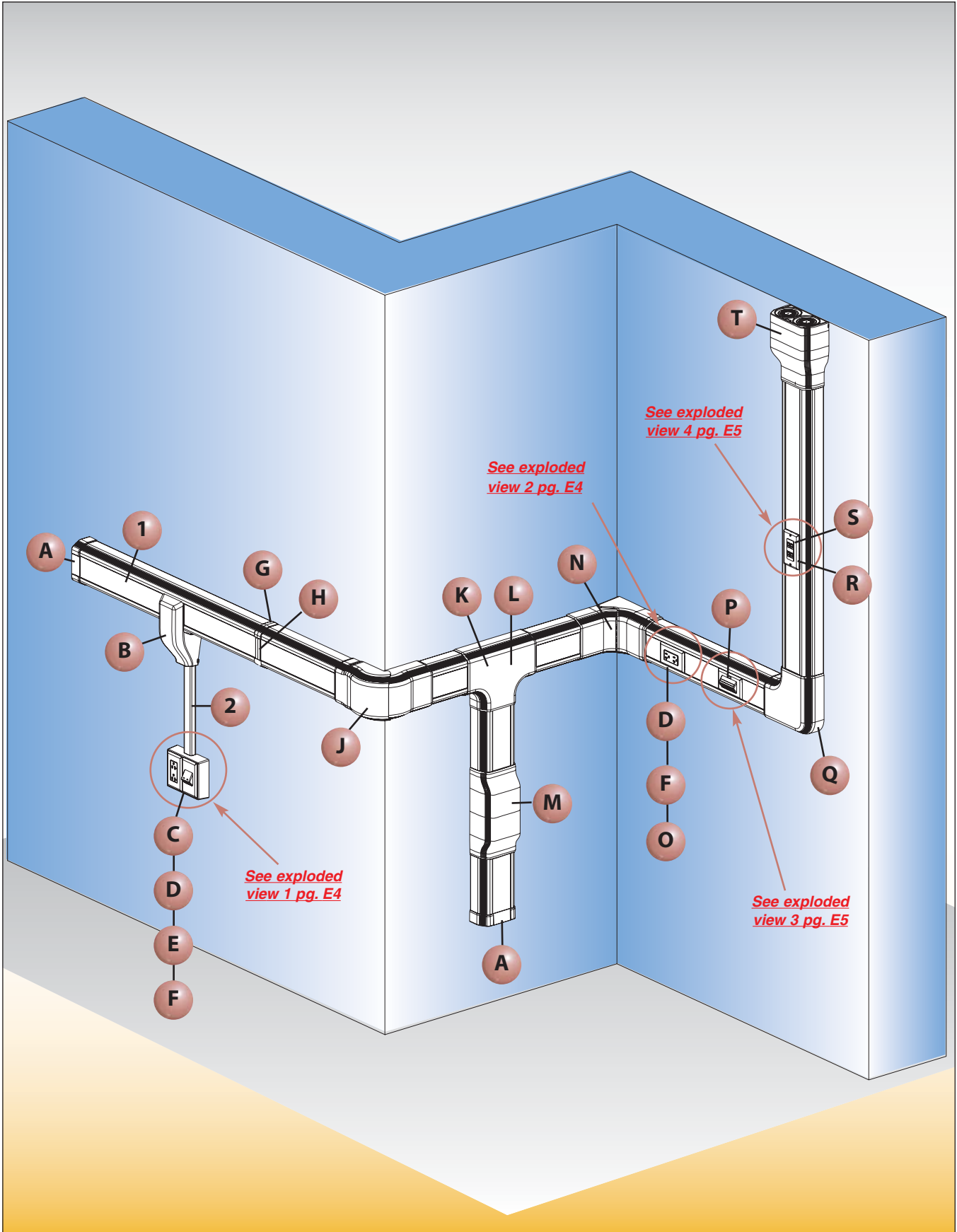

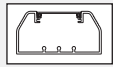

1 **TG-70** — TG-70 Raceway Base and Cover (page E6)**

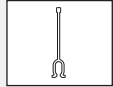

1 **TGDW — TG-70 Raceway Divider Wall (page E6)**

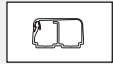

2 **LD2P10** — LD2P10 Raceway (page K13)**



A **TGEC** — TG-70 End Cap (page E7)**



B **TGTR** — TG-70 Transition Fitting (page E7)**

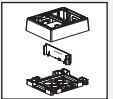

C **JBP2FS** — FAST-SNAP™ Double Gang Power Rated Surface Mount Box (page J2)**

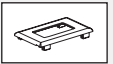

D **T70PG** — Single Gang Rectangular Electrical/Communication Snap-on Faceplate (page J3)**

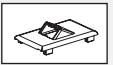

E **T70FV2** — Vertical Sloped Communication Snap-on Faceplate (page J2)**

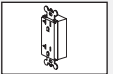

F **ERU20** — 20A Rectangular Electrical Outlet (page J11)**



G **TG70BC** — TG-70 Base Couplers (page E7)**

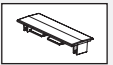

H **T70CC** — T-70 Cover Couplers (page E7)**

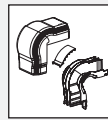

J **TGOC** — TG-70 Outside Corner Fitting (page E7)**



K **TGT** — TG-70 Tee Fitting (page E7)**



L **TGTD — TG Tee Divider (page E7)**

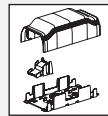

M **TGBF** — TG-70 Backfeed Fitting (page E7)**

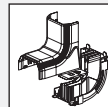

N **TGIC** — TG-70 Inside Corner Fitting (page E7)**

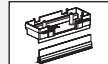

O **TG70HB3-X — TG-70 Hanging Box with Divider Wall (page E8)**



P **UIT70FH4** — ULTIMATE ID™ Sloped Horizontal Snap-on Faceplate (page H5)**

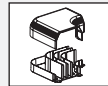

Q **TGRA** — TG-70 Right Angle Fitting (page E7)**

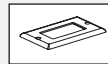

R **CPG** — Single Gang Rectangular Power and Communication Faceplate (page J10)**

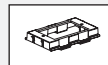

S **T70DB-X — T-70 Device Bracket (page E8)**

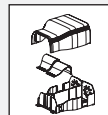

T **TGEE** — TG-70 Entrance End Fitting (page E7)**

TG-70 Configurations

Exploded view 1

	Components Required	See page
A.	T70FV2 = Vertical Sloped Communication Snap-on Faceplate.	J2
B.	PAN-NET® Connectivity.	—
C.	T70PG = Single Gang Rectangular Electrical/Communication Snap-on Faceplate.	J3
D.	ERU20 = 20A Rectangular Electrical Outlet (screws included).	J11
E.	JBP2FS = FAST-SNAP™ Double Gang Power Rated Surface Mount Outlet Box.	J2

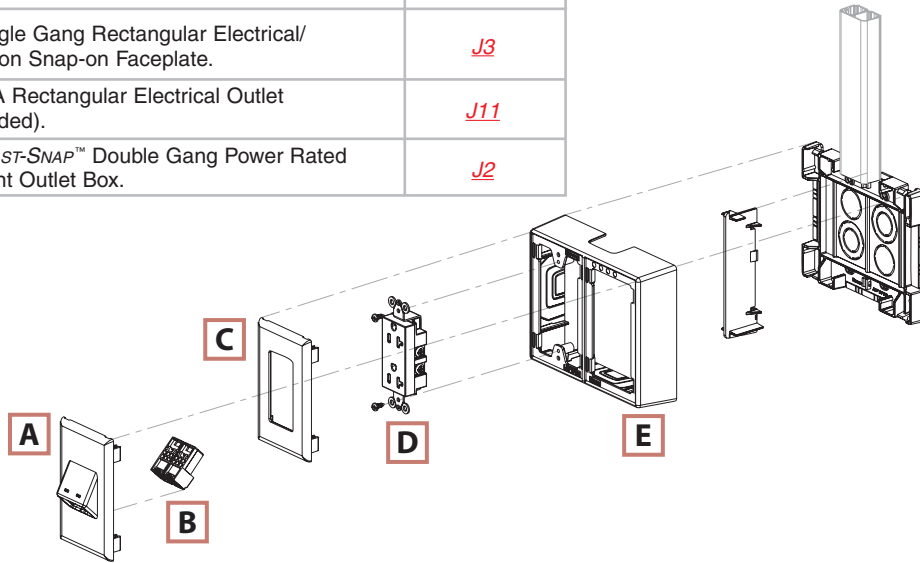

Exploded view 2

	Components Required	See page
A.	T70PG = Single Gang Rectangular Electrical/Communication Faceplate.	J3
B.	ERU20 = 20A Rectangular Electrical Outlet (screws included).	J11
C.	TG70HB3 = TG-70 3-Sided Hanging Box.	E8

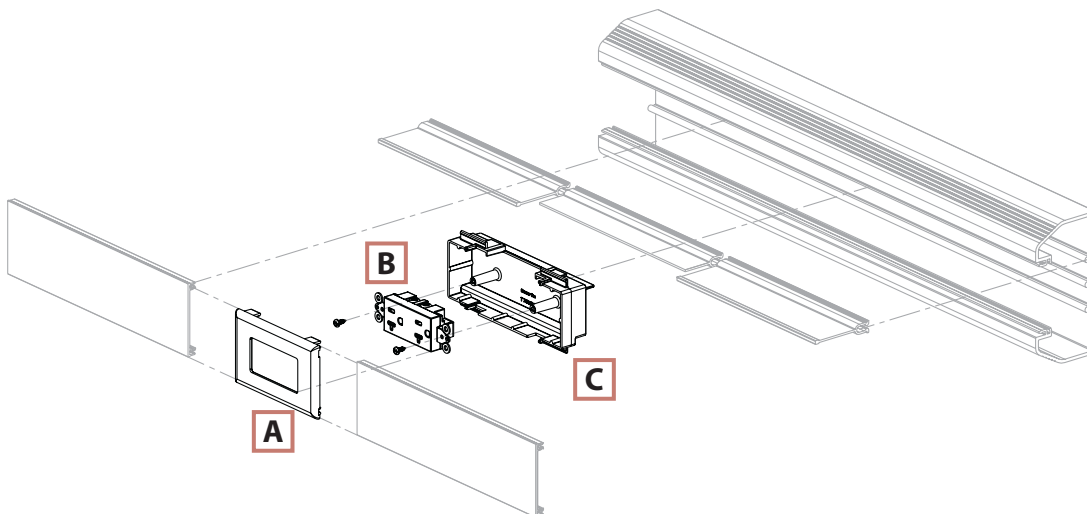

TG-70 Configurations (Continued)

Exploded view 3

	Components Required	See page
A.	UIT70FH4 = <i>ULTIMATE ID™</i> Sloped Horizontal Snap-on Faceplate — 4 Port.	<i>H5</i>
B.	<i>PAN-NET®</i> Connectivity.	—

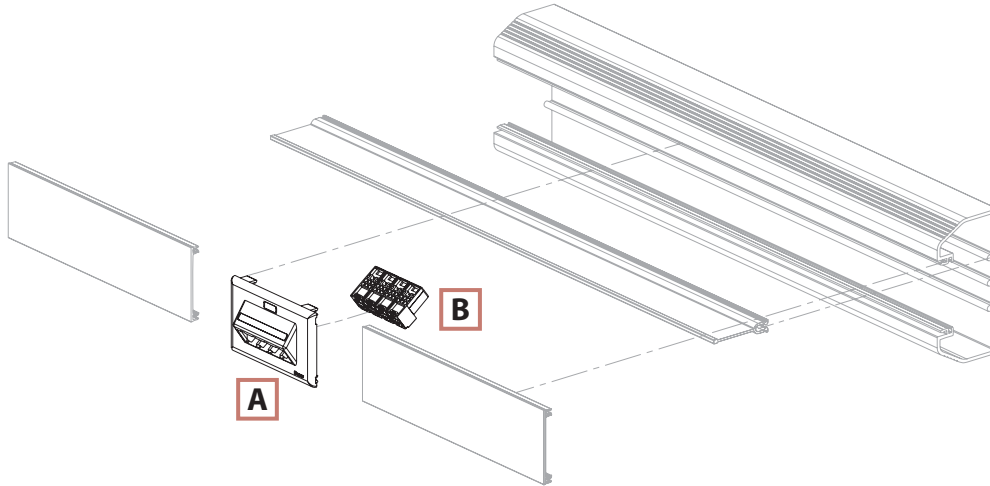

Exploded view 4

	Components Required	See page
A.	CPG = Single Gang Rectangular Screw-on Faceplate (screws included).	<i>J10</i>
B.	<i>PAN-NET®</i> Connectivity.	—
C.	T70DB = T70 Device Bracket.	<i>E8</i>

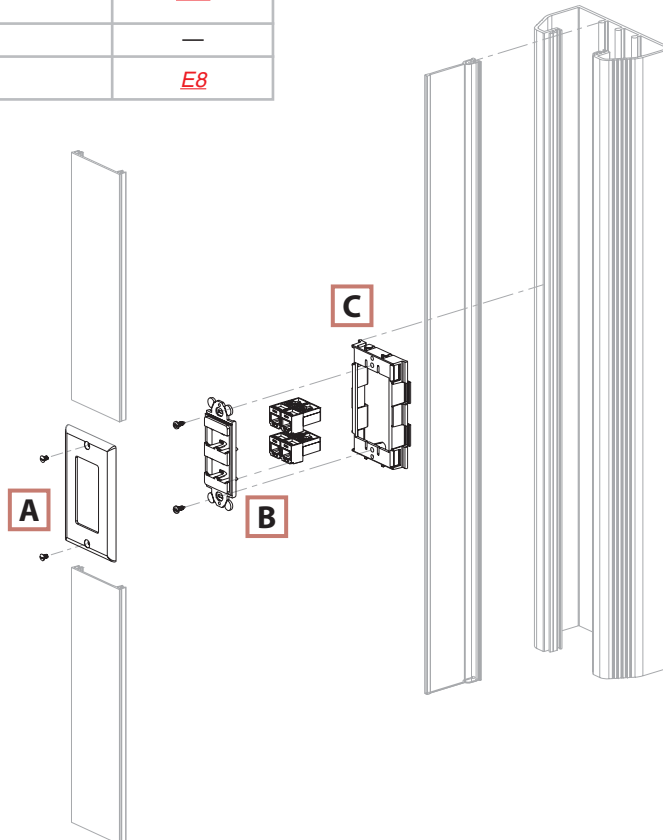

PANDUIT®

NON-METALLIC SURFACE RACEWAY



PAN-WAY® TG-70 Surface Raceway System

- UL & CSA rated 600V; meets UL5A and CSA C22.2 No. 62.1-03 standards
- Large cable capacity with aesthetically pleasing design
- Tamper resistant

- Compatible with NEMA standard faceplates or PAN-WAY® Classic Series Snap-on Faceplates
- Transitions to PANDUIT® T-45 and LD Profile Raceway
- Supplied with pre-punched mounting holes

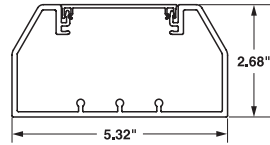

Internal Area = 10.85 Sq. In.



TG70

Part Number	Part Description	Raceway Size	Color‡	Length (ft)	Std. Ctn. Qty.
TG-70 Raceway Base and Cover — PACKAGED TOGETHER					
TG70IW8	TG-70 Raceway Base and Cover in 8' and 10' lengths. Supplied with pre-punched mounting holes.	5.32" x 2.68"	Off White	8	32
TG70IW10				10	40



T70C

T-70/TE-70/TG-70/Twin-70 Raceway Cover

T70CIW8	T-70, TG-70, TE-70 or Twin-70 Raceway Cover in 8' and 10' lengths.	—	Off White	8	96
T70CIW10				10	120

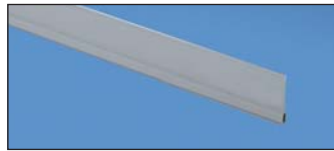

TGDW

TG Raceway Divider Wall

TGDW8	TG Raceway Divider Wall. Snaps onto rails in TG Raceway Base to create separate channels. Must use wire retainers to ensure channel separation per UL/CSA. Available in 8' and 10' lengths.	—	Gray	8	64
TGDW10				10	80

‡ For other colors replace IW (Off White) with EI (Electric Ivory).
Order number of feet required in multiples of standard carton quantity.



Type TG-70 Fittings

- TG-70 fittings are designed to exceed the TIA/EIA 568-B and 569-B required minimum bend radius for high performance copper and fiber optic cabling systems



T70CC



TG70BC



TGRA



TGIC



TGSIC



TGOIC



TGSOC



TGT



TGTR



TGEC



TGEE



TGTD



TGBF



TGBFI

Part Number	Part Description	Color‡	Std. Pkg. Qty.	Std. Ctn. Qty.
T70CCIW-X	Cover Coupler Fitting. Used to join sections of cover together.	Off White	10	100
TG70BCIW-X	Base Coupler Fitting. Each piece includes 2 base coupler halves for joining sections of TG-70 Base together.	Off White	10	100
TGRAIW	Right Angle Fitting. Used to join sections of TG Raceway at 90° flat junctions.	Off White	1	10
TGICIW	Inside Corner Fitting. Used to join sections of TG Raceway at inside corners. Fittings adjust from 85° to 135° to adapt to non-square corners.	Off White	1	—
TGSICIW	Inside Corner Fitting — Non-adjustable. Used to join sections of TG Raceway at inside corners.	Off White	1	10
TGOCIW	Outside Corner Fitting. Used to join sections of TG Raceway at outside corners. Fittings adjust from 85° to 135° to adapt to non-square corners.	Off White	1	—
TGSOCIW	Outside Corner Fitting — Non-adjustable. Used to join sections of TG Raceway at outside corners.	Off White	1	10
TGTIW	Tee Fitting. Used to join sections of TG Raceway at tee intersections.	Off White	1	5
TGTRIW	Transition Fitting from TG to T-45. Provides a tee transition from TG Raceway to T-45 and LD series size 5 and 10. Use with RF5X3 Reducer Fitting to transition to LD series size 3.	Off White	1	10
TGECIW	End Cap. Used to terminate or allow entry to TG Raceway. Two knockouts each for ½" (16mm) and 1" (27mm) conduit.	Off White	1	10
TGEEIW	Entrance End Fitting. Accepts large conduit, (up to 2") in line or at a right angle. Maintains a 40mm bend radius with a removable insert and channel separation.	Off White	1	10
TGTD	Tee Divider Insert. Mounts inside TGT Tee Fitting to maintain channel separation in TG Raceway at tee intersections.	Gray	1	5
TGBFIW	Backfeed Fitting. Features breakouts to enter through the bottom of the fitting and maintains bend radius control with a removable, bend radius insert and channel separation.	Off White	1	10
TGBFI	Backfeed Fitting Insert. Removable and maintains bend radius control.	Off White	1	10

‡ For other colors replace IW (Off White) with EI (Electric Ivory).

Type TG-70 Raceway Accessories

- TG-70 accessories consist of device mounting brackets, standard faceplate brackets for data, wire retainers, and fiber spool brackets. The three-sided hanging box is used to mount NEMA standard single gang outlet and communications devices

Part Number	Part Description	Color	Std. Pkg. Qty.	Std. Ctn. Qty.
T70DB-X	Device Mounting Bracket. Used to mount NEMA standard single gang electrical outlets and communication devices with either screw-on or snap-on single gang faceplates. Can be used with T-70, Twin-70, TE-70, and TG-70 Raceways.	Gray	10	100
T70SDB-X	Standard Faceplate Bracket. Used to mount NEMA standard single gang screw-on electrical/communication faceplates only.	Gray	10	100
TG70HB3-X	Three-sided Hanging Box. Mounts standard electrical outlets or communication devices with either NEMA standard single gang screw-on or <i>PANDUIT</i> ® Snap-on Faceplates. When used with TGDW Divider Wall, box separates and fully encloses device to provide cabling separation.	Gray	10	100
TG70HB3GFCI-X	GFCI Three-sided Hanging Box. Accepts single gang U.S. GFCI (ground fault circuit interrupter) standard electrical devices. Provides increased internal area for connections and excess wire.	Gray	10	—
TG70WR-X	Wire Retainer. Holds wires in place during installation.	Gray	10	100
TGFSB	Fiber Spool Bracket. Each piece consists of two halves that snap into base of TG Raceway. Provides method to contain one meter or more of fiber slack and acts as a strain relief while maintaining a minimum 32mm bend radius. Bracket separation can be adjusted to fit the length of slack required.	Gray	1	10

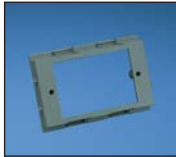

T70DB-X



T70SDB-X

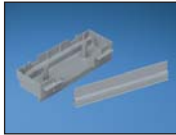

TG70HB3-X



TG70HB3GFCI-X

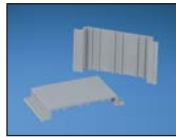

TG70WR-X

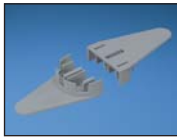

TGFSB



TGFSB installed in TG-70 Raceway

Quick Wire Fill Capacities for TG-70 Raceway

This information is to be used as a guide in selecting the proper size raceway. The maximum amounts may vary according to the wire installation methods, straightness of wires, etc.

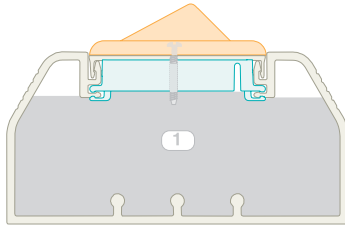

A = 10.09 in²

Wirefill #1: With Data only using Screw-on Faceplates and devices.

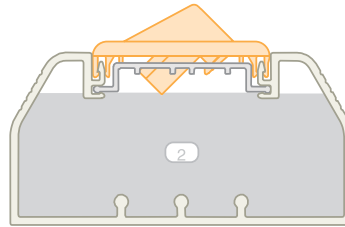

A = 10.68 in²

Wirefill #2: With Data only using Snap-on Faceplates and Wire Retainer.

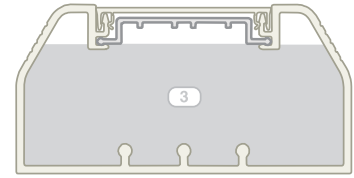

A = 10.85 in²

Wirefill #3: With Wire Retainer.

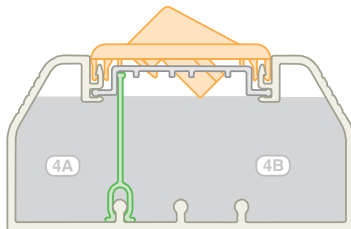

A = 3.16 in²

A = 7.20 in²

Wirefill #4: Divided (see 5A and 5B for power and data applications).

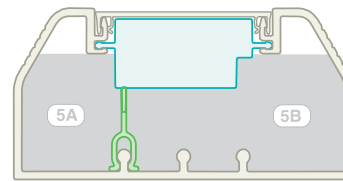

A = 3.08 in²

A = 5.58 in²

Wirefill #5: With Power and data using Snap-on Faceplates and 3-Sided Power Box.

SPEC = 40% wire fill — The recommended design in cable capacity, leaves room for future moves, adds and changes.

MAX for Data = 60% wire fill — The maximum cable quantity based on cable interweaving and packing factors.

MAX for Power wire fill — The maximum number of electrical cables based on UL temperature rise test.

Raceway Type & Configuration	Fill Area (in ²)	Electrical Cables			Data Grade Cable	Data Grade Cable	Coax Cable		Fiber Optic Cable			
		14 AWG	12 AWG	10 AWG	24 AWG/UTP CM	24 AWG/UTP CM	RG6		2 Strand			
		THHN/T90			Cat 5e (4pr)		Cat 6 (4pr)		DIA. = .275		DIA. = .175	
		.105	.122	.153	DIA. = .217		DIA. = .250		DIA. = .275		DIA. = .175	
		FILL			FILL		FILL		FILL		FILL	
MAX	MAX	MAX	SPEC	MAX	SPEC	MAX	SPEC	MAX	SPEC	MAX	MAX	
(UL Temp Rise Test)			(40%)		(60%)		(40%)		(60%)		(40%)	
1. TG70: Data only using Screw-on Faceplates and Devices.	10.09	—	—	—	92	138	82	123	53	80	164	247
2. TG70: Data only using Snap-on Faceplates and Wire Retainer.	10.68	—	—	—	97	146	87	130	56	85	174	261
3. TG70: Wire Retainer without devices.	10.85	40	40	38	99	148	88	132	57	86	177	265
4A. TG70: Divided power and data (A).	3.16	28	28	26	28	43	25	38	17	25	51	77
4B. TG70: Divided power and data (B).	7.2	—	—	—	65	98	58	88	38	57	117	176
5A. TG70: Power and data using Snap-on Faceplates and 3 Sided Power Box (A).	3.08	28	28	26	28	42	25	37	16	24	50	75
5B. TG70: Power and data using Snap-on Faceplates and 3 Sided Power Box (B).	5.58	—	—	—	51	76	45	68	30	44	91	136

System
Overview

Quick
Selection
Guide

Office
Furniture

Cove

TG-70

T-70
&
Twin-70

T-45

Ultimate
ID
System

Faceplate,
Boxes &
Labeling

LD Profile

T130

Outlet
Pole

Technical
Info

Index

PANDUIT[®]

NON-METALLIC SURFACE RACEWAY

NOTES

PAN-WAY® T-70 AND TWIN-70 NON-METALLIC SURFACE RACEWAY

PAN-WAY® Non-Metallic T-70 and Twin-70 Surface Raceways are multi-channel raceways which provide solutions for routing low voltage, fiber optic and/or power cabling along fixed perimeter walls. The T-70 and Twin-70 Raceway Systems consist of raceway base, cover, fittings, termination hardware, and accessories.



Type T-70:

- T-70 utilizes a single channel with snap-in divider wall to provide multi channel capability
- Aesthetically pleasing
- Lightweight
- Tamper resistant
- Fittings maintain 1" bend radius control

Type Twin-70:

- Twin-70 utilizes two independent channels and covers to provide multi-channel capability
- Aesthetically pleasing
- Lightweight
- Tamper resistant
- Fittings maintain 1" bend radius control

PANDUIT® T-70 and Twin-70 Raceway can mount NEMA standard screw-on faceplates or superior PAN-WAY Snap-on Faceplates directly to the channel. T-70 features the WORKSTATION OUTLET CENTER™ Offset Box which provides an offset solution to maximize channel capacity and outlet density. Twin-70 offers two totally independent channels maintained throughout the system for independent access to power, low voltage and fiber optic cabling. Fittings for T-70 and Twin-70 are available to transition to T-70, Twin-70, T-45 and LD Raceways.

T-70 Raceway Roadmap

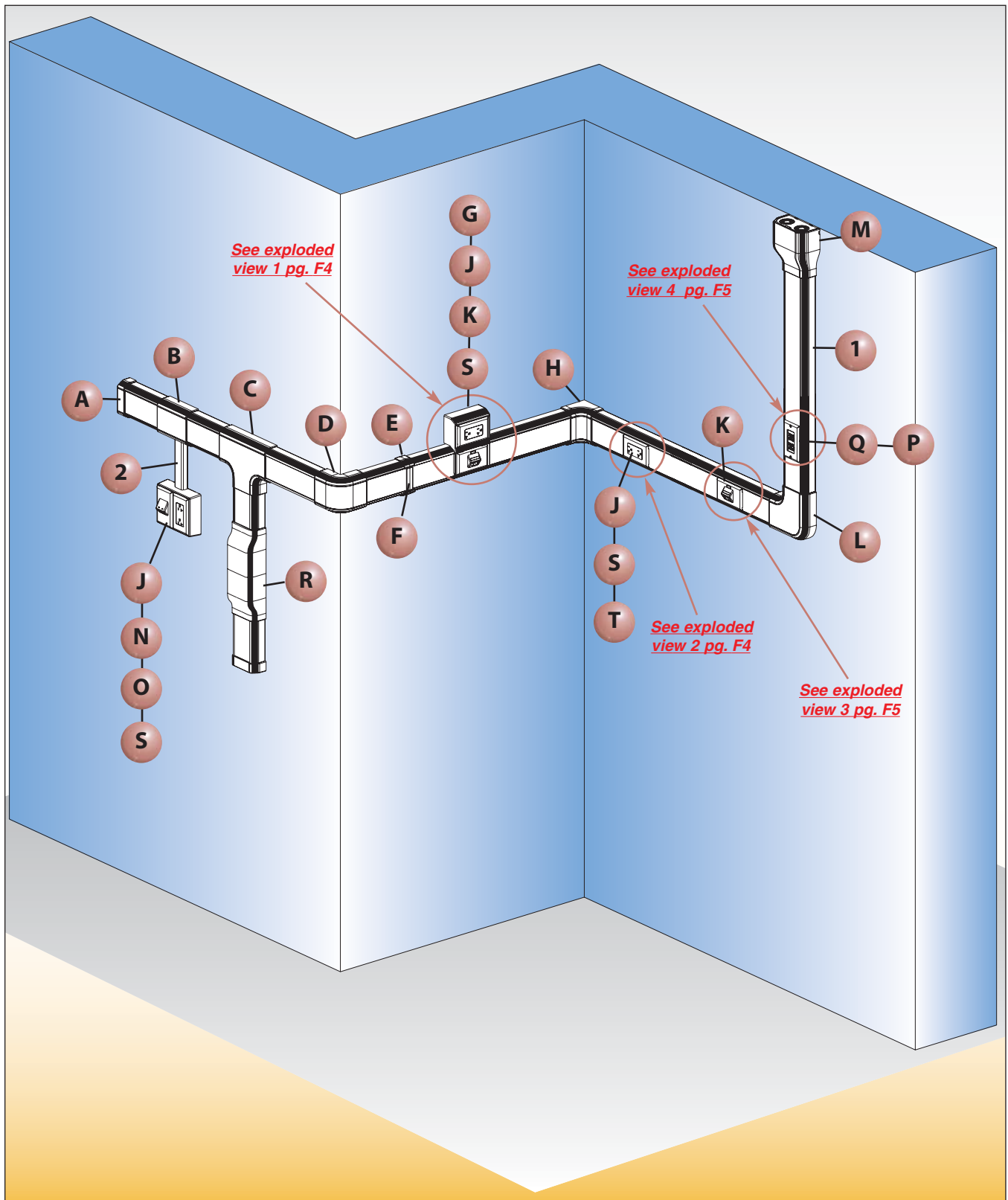

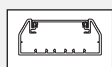

1 ***T70B*****, ***T70C***** — ***T-70 Base and Cover (page F8)***

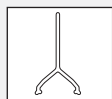

1 ***T70DW*** — ***T-70 Divider Wall (page F8)***



2 ***LD2P10***** — ***LD2P10 Raceway (page K13)***



A ***T70EC***** — ***T-70 End Cap Fitting (page F9)***



B ***T70TR***** — ***T-70 Transition Fitting (page F9)***



C ***T70T***** — ***T-70 Tee Fitting (page F8)***



D ***T70OC***** — ***T-70 Outside Corner Fitting (page F8)***



E ***T70BC***** — ***T-70 Base Coupler Fitting (page F8)***



F ***T70CC***** — ***T-70 Cover Coupler Fitting (page F8)***



G ***T70WC2***** — ***T-70 WORKSTATION OUTLET CENTER OFFSET™ Box for Snap-On Faceplates (page F9)***

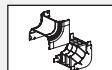

H ***T70IC***** — ***T-70 Inside Corner Fitting (page F8)***



J ***T70PG***** — ***Single Gang Rectangular Electrical Communication Snap-On Faceplate (page J3)***



K ***UIT70FH2***** — ***ULTIMATE ID™ Sloped Horizontal Snap-On Faceplate (page H5)***



L ***T70RA***** — ***T-70 Right Angle Fitting (page F8)***

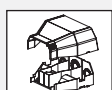

M ***T70EE***** — ***T-70 Entrance End Fitting (page F9)***

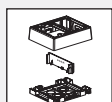

N ***JBP2FS***** — ***FAST-SNAP™ Double Gang Power Rated Surface Mount Outlet Box (page J2)***



O ***T70FV2***** — ***Vertical Sloped Communication Snap-On Faceplate (page J2)***



P ***T70DB-X*** — ***T-70 Device Bracket (page F12)***

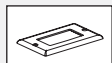

Q ***CPG***** — ***Single Gang Rectangular Screw-On Faceplate (page J10)***

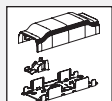

R ***T70BF***** — ***T-70 Backfeed Fitting (page F9)***

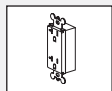

S ***ERU20***** — ***20A Rectangular Electrical Outlet (page J11)***

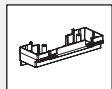

T ***T70HB3-X*** — ***Three-Sided Hanging Box (page F12)***

T-70 Configurations

Exploded view 1

	Components Required	See page
A.	T70WC2 = T-70 <i>WORKSTATION OUTLET CENTER™</i> Offset Box for Snap-On Faceplates.	F9
B.	ERU20 = 20A Rectangular Electrical Outlet (screws included).	J11
C.	<i>PAN-NET®</i> Connectivity.	—
D.	T70PG = Single Gang Rectangular Electrical/Communication Snap-On Faceplate.	J3
E.	UIT70FH2 = <i>ULTIMATE ID™</i> Sloped Horizontal Snap-On Faceplate — Two Port.	H5

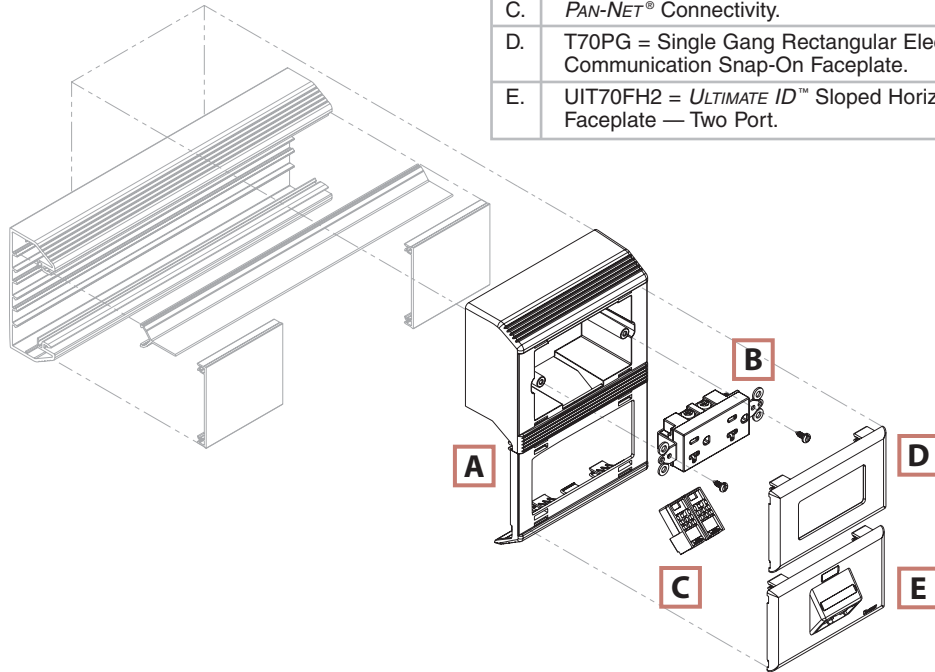

Exploded view 2

	Components Required	See page
A.	T70PG = Single Gang Rectangular Electrical/Communication Snap-On Faceplate.	J3
B.	ERU20 = 20A Rectangular Electrical Outlet (screws included).	J11
C.	T70HB3-X = Three-Sided Hanging Box.	F12

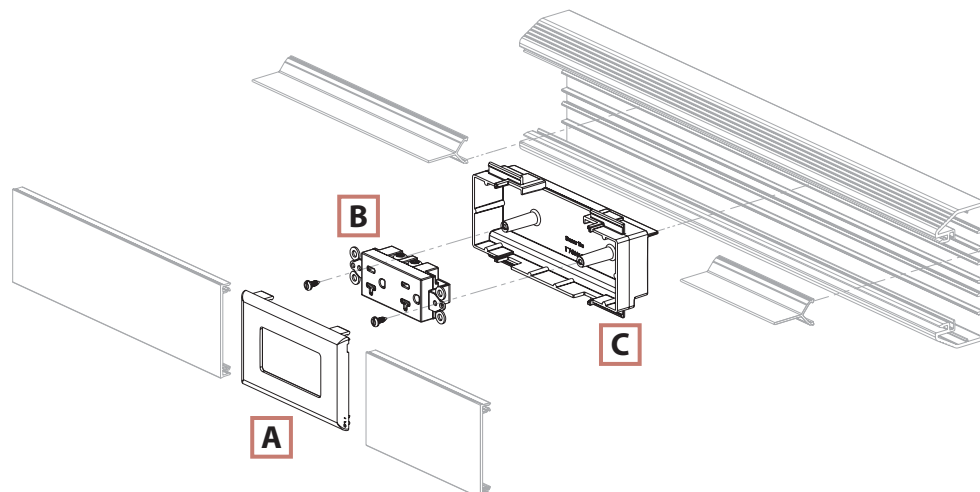

T-70 Configurations (Continued)

Exploded view 3

	Components Required	See page
A.	UIT70FH2 = <i>ULTIMATE ID™</i> Sloped Horizontal Snap-On Faceplate — Two Port.	<i>H5</i>
B.	<i>PAN-NET®</i> Connectivity.	—

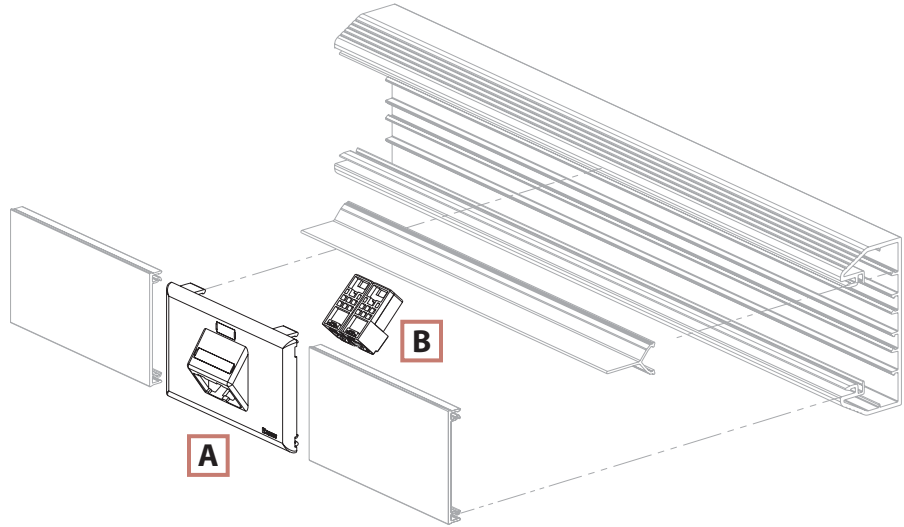

Exploded view 4

	Components Required	See page
A.	CPG = Single Gang Rectangular Screw-On Faceplates (screws included).	<i>J10</i>
B.	<i>PAN-NET®</i> Connectivity.	—
C.	T70DB-X = T-70 Device Bracket.	<i>F12</i>

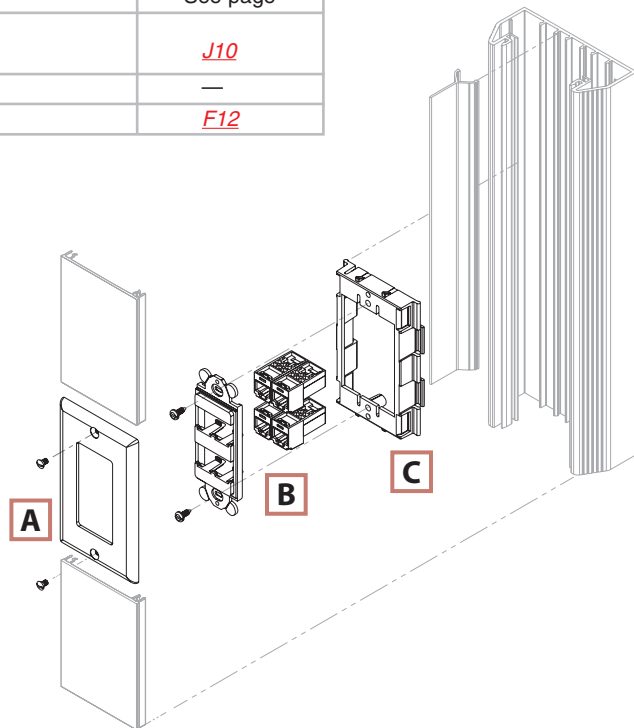

Twin-70 Raceway Roadmap

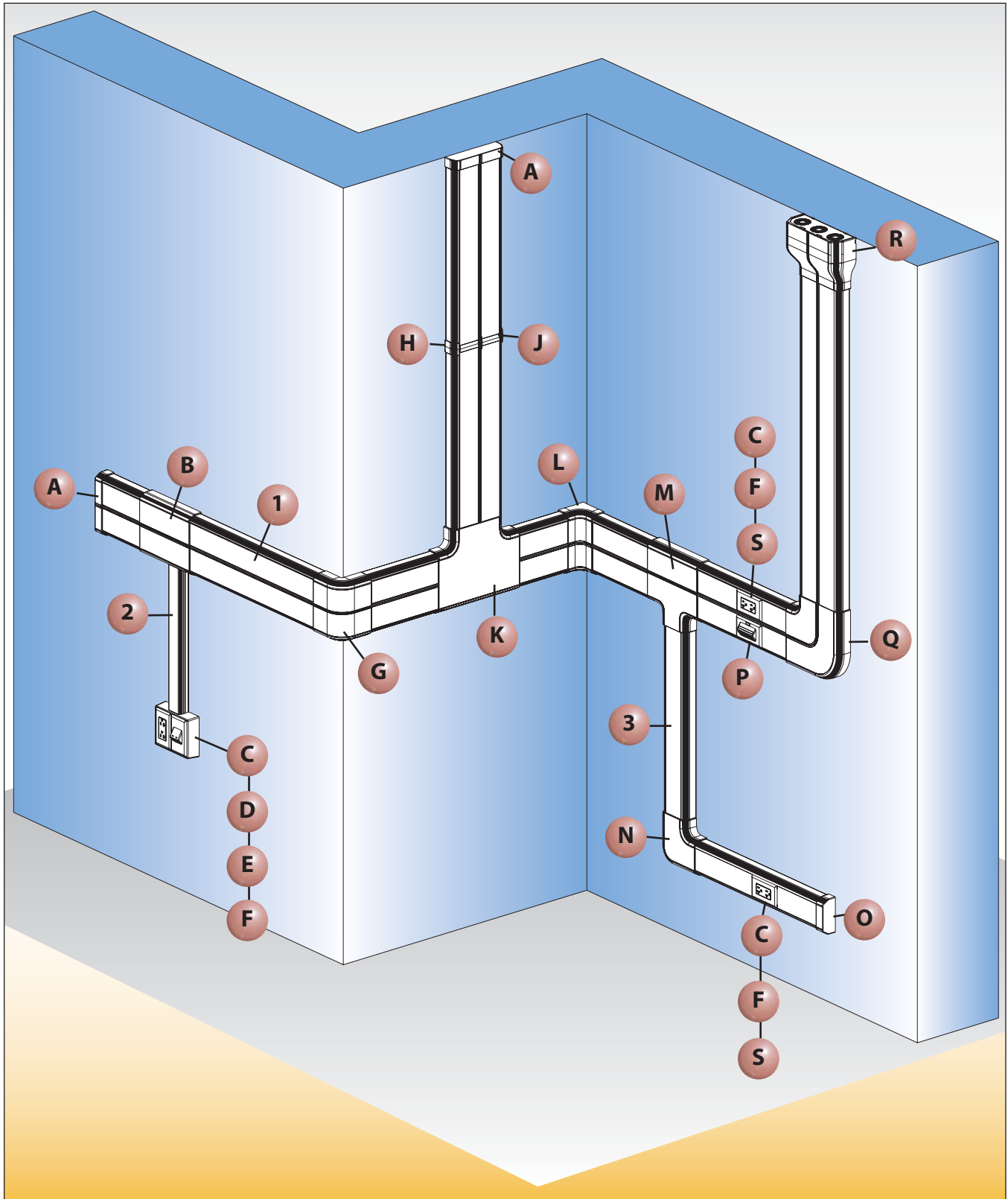

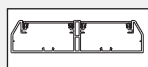

1 ***T702B*****, ***T70C***** — ***Twin-70 Raceway Base and Cover (page F10)***

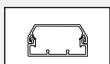

2 ***T45B*****, ***T45C***** — ***T-45 Raceway Base and Cover (page G6)***

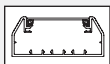

3 ***T70B*****, ***T70C***** — ***T-70 Raceway Base and Cover (page F8)***



A ***T702EC***** — ***Twin-70 End Cap Fitting (page F11)***

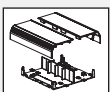

B ***T702TRL***** — ***Twin-70 Transition Fitting (page F11)***

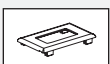

C ***T70PG***** — ***Single Gang Rectangular Electrical/Communication Snap-On Faceplate (page J3)***

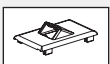

D ***T70FV2***** — ***Vertical Sloped Communication Snap-On Faceplate (page J2)***

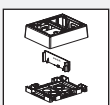

E ***JBP2FS***** — ***FAST-SNAP™ Double Gang Power Rated Surface Mount Outlet Box (page J2)***

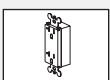

F ***ERU20***** — ***20A Rectangular Electrical Outlet (page J11)***



G ***T702OC***** — ***Twin-70 Outside Corner Fitting (page F11)***



H ***T702BC***** — ***Twin-70 Base Coupler Fitting (page F11)***



J ***T70CC***** — ***T-70 Cover Coupler Fitting (page F8)***

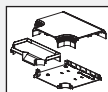

K ***T702T***** — ***Twin-70 Tee Fitting (page F11)***



L ***T702IC***** — ***Twin-70 Inside Corner Fitting (page F11)***

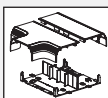

M ***T702TR***** — ***Twin-70 Transition Fitting (page F11)***



N ***T70RA***** — ***T-70 Right Angle Fitting (page F8)***



O ***T70EC***** — ***T-70 End Cap Fitting (page F9)***



P ***UIT70FH4***** — ***ULTIMATE ID™ Sloped Horizontal Snap-On Faceplate (page H5)***



Q ***T702RA***** — ***Twin-70 Right Angle Fitting (page F11)***

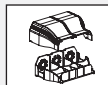

R ***T702EE***** — ***Twin-70 Entrance End Fitting (page F11)***

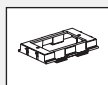

S ***T70DB-X***** — ***T-70 Device Mounting Bracket (page F12)***

PANDUIT®**NON-METALLIC SURFACE RACEWAY****PAN-WAY® T-70 Surface Raceway System**

- UL & CSA rated 600V; meets UL5A and CSA C22.2 No. 62.1-03 standards
- Large cable capacity with aesthetically pleasing design
- Tamper resistant

- Compatible with NEMA standard 70mm faceplates or PAN-WAY® Classic Series Snap-on Faceplates
- Transitions to PANDUIT® T-45 and LD Profile Raceways
- Supplied with pre-punched mounting holes

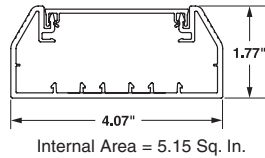
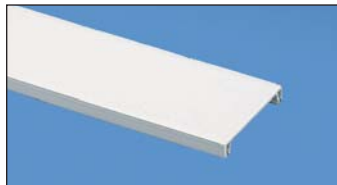
**T70B****T70C****T70DW**

Part Number	Part Description	Raceway Size	Color‡	Length (ft)	Std. Ctn. Qty.
-------------	------------------	--------------	--------	-------------	----------------

T-70 Raceway Base

T70BIW8	T-70 Raceway Base in 8' and 10' lengths. Supplied with pre-punched mounting holes.	4.07" x 1.77"	Off White	8'	48
T70BIW10				10'	60

T-70/TE-70/TG-70/Twin-70 Raceway Cover

T70CIW8	T-70, TG-70, TE-70 or Twin-70 Raceway Cover in 8' and 10' lengths.	-	Off White	8'	96
T70CIW10				10'	120

T-70/Twin70 Raceway Divider Wall

T70DW8	T-70/Twin70 Raceway Divider Wall. Snaps onto rails in T-70/Twin-70 Raceway base to create separate channels. Must use wire retainers to ensure channel separation per UL/CSA. Available in 8' and 10' lengths.	-	Gray	8'	96
T70DW10				10'	120

‡ For other colors replace IW (Off White) with EI (Electric Ivory) or WH (White).
Order raceway base and cover separately.
Order number of feet required in multiples of standard carton quantity.





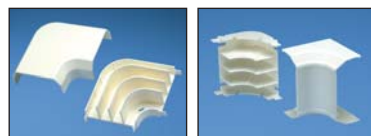
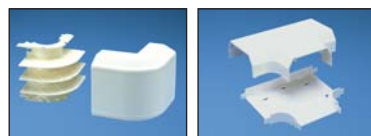



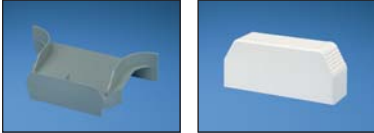

Type T-70 Fittings

- T-70 fittings are designed to maintain the TIA/EIA 568-B and 569-B required minimum bend radius for high performance copper and fiber optic cabling systems

**T70CC****T70BC****T70RA****T70IC****T70OC****T70T**

Part Number	Part Description	Color‡	Std. Pkg. Qty.	Std. Ctn. Qty.
T70CCIW-X	Cover Coupler Fitting. Used to join sections of cover together.	Off White	10	100
T70BCIW-X	Base Coupler Fitting. Used to join sections of T70 Raceway Base together.	Off White	10	100
T70RAIW	Right Angle Fitting. Used to join sections of T-70 Raceway at right angles.	Off White	1	10
T70ICIW	Inside Corner Fitting. Used to join sections of T-70 Raceway at inside corners.	Off White	1	10
T70OCIW	Outside Corner Fitting. Used to join sections of T-70 Raceway at outside corners.	Off White	1	10
T70TIW	Tee Fitting. Used to join sections of T-70 Raceway at tee intersections.	Off White	1	10

Type T-70 Fittings (Continued)

Part Number	Part Description	Color‡	Std. Pkg. Qty.	Std. Ctn. Qty.
 T70TDT, T70TDC, T70TDB	T70TDT Raceway Divider Inserts (power & data applications). Separates power and data within tee fitting when divider wall is placed in top position.	Gray	1	10
 T70EC	T70TDC Raceway Divider Inserts (power & data applications). Separates power and data within tee fitting when divider wall is placed in center position.	Gray	1	10
 T70EE	T70TDB Raceway Divider Inserts (power & data applications). Separates power and data within tee fitting when divider wall is placed in bottom position.	Gray	1	10
 T70TR, T70TRC	T70ECIW End Cap Fitting. Used to terminate or allow entry to T-70 Raceway with conduit breakouts of 1/2".	Off White	1	10
 T70TRI	T70EEIW Entrance End Fitting. Conduit breakouts of 1/2", 3/4" 1" and 1 1/4" which allows entry from ceiling or wall.	Off White	1	10
 T70WM40TR	T70TRIW Transition Fitting. Used to transition to any LD Profile or T-45 Raceway while maintaining channel separation. Fitting includes bend radius insert.	Off White	1	10
 T70BF	T70TRCIW Transition Fitting Cover. Used to transition to any LD Profile or T-45 Raceway.	Off White	1	10
 T70BFI	T70TRI Divided Insert for T-70 to LD2P10. Maintains channel separation within T70TR fitting.	Gray	1	10
 T70WC	T70WM40TRIW Wiremold* to T-70 Transition Fitting. In-line transition fitting from Wiremold G4000 to T-70 Raceway.	Off White	1	10
 T70WC2	T70BFIW Backfeed Fitting. Allows cable entry through the back of the T70 Raceway.	Off White	1	10
	T70BFI Backfeed Fitting Insert. Bend radius insert to be used with T70BF.	Gray	1	10
WORKSTATION OUTLET CENTER™ Offset Box for T-70 Raceway				
	T70WC1W WORKSTATION OUTLET CENTER™ Offset Box for Screw-on Faceplates. Two-piece box & bracket accept any NEMA standard screw-on faceplate.	Off White	1	10
	T70WC21W WORKSTATION OUTLET CENTER™ Offset Box for PAN-WAY® Snap-on Faceplates. Two-piece box & bracket accept any standard electrical outlet. Accepts any PAN-WAY® Snap-on Electrical/Communication Faceplates.	Off White	1	10

‡ For other colors replace IW (Off White) with EI (Electric Ivory) or WH (White).

*Wiremold is a registered trademark of the Wiremold Co.

Tee Insert Configurations

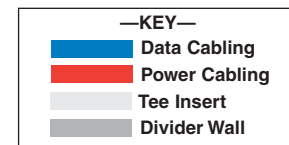
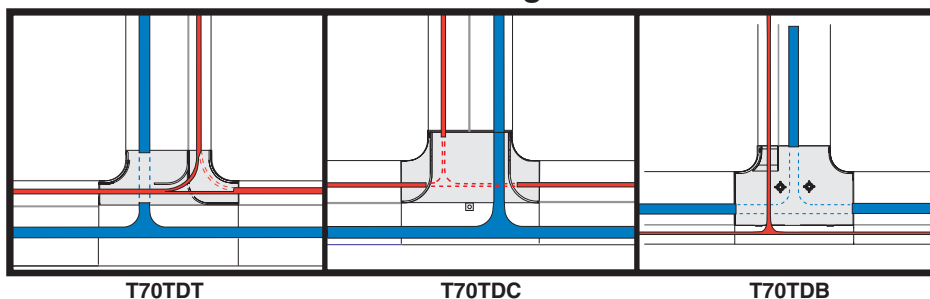

Divided Tee Inserts are used to separate power and data cabling for various tee configurations. Maintains 1" bend radius of data cables.

PANDUIT® NON-METALLIC SURFACE RACEWAY

UL SA LISTED **PAN-WAY® Twin-70 Surface Raceway System**

- UL & CSA rated 600V; meets UL5A and CSA C22.2 No. 62.1-03 standards
- Separate channels allow independent access to power and communication cabling throughout the entire system
- Transitions to *PANDUIT®* T-70, T-45 and LD Profile Raceways
- Compatible with NEMA standard 70mm faceplates or *PAN-WAY®* Classic Series Snap-on Faceplates
- Tamper resistant
- Supplied with pre-punched mounting holes

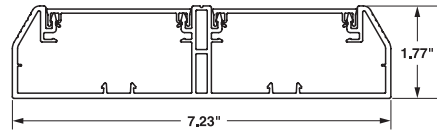

Left Internal Area = 4.59 Sq. In.
Right Internal Area = 4.59 Sq. In.



T702B

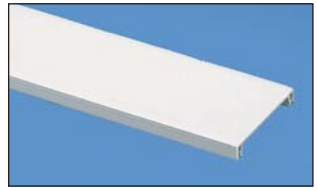

T70C

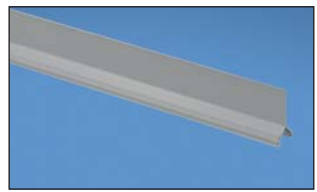

T70DW

Part Number	Part Description	Raceway Size	Color‡	Length (ft)	Std. Ctn. Qty.
Twin-70 Raceway Base					
T702BIW8	Twin-70 Raceway Base in 8' and 10' lengths. Supplied with pre-punched mounting holes.	7.23" x 1.77"	Off White	8	24
T702BIW10				10	30

T-70/TE-70/TG-70/Twin-70 Raceway Cover					
T70CIW8	T-70, TG-70, TE-70 or Twin-70 Raceway Cover in 8' and 10' lengths.	-	Off White	8	96
T70CIW10				10	120

T-70 Raceway Divider Wall					
T70DW8	T-70/Twin70 Raceway Divider Wall. Snaps onto rails in T-70/Twin-70 Raceway base to create separate channels. Must use wire retainers to ensure channel separation per UL/CSA. Available in 8' and 10' lengths.	-	Gray	8	96
T70DW10				10	120

‡ For other colors replace IW (Off White) with EI (Electric Ivory) or WH (White).
Two feet of cover needed for every foot of Twin-70 Base.
Order number of feet required in multiples of standard carton quantity.

Type Twin-70 Fittings

- Twin-70 fittings are designed to maintain the TIA/EIA 568-B and 569-B required minimum bend radius for high performance copper and fiber optic cabling systems



T70CC



T702BC



T702RA



T702IC



T702OC



T702T



T702EC



T702EE



T702TR



T702TRL

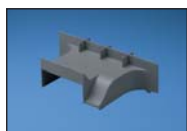







T702TRI

Part Number	Part Description	Color‡	Std. Pkg. Qty.	Std. Ctn. Qty.
T70CCIW-X	Cover Coupler Fitting. Used to join sections of cover together.	Off White	10	100
T702BCIW-X	Base Coupler Fitting. Used for joining sections of Twin-70 Base together.	Off White	10	100
T702RAIW	Right Angle Fitting. Used to join sections of Twin-70 Raceway at 90° flat junctions.	Off White	1	10
T702ICIW	Inside Corner Fitting. Used to join sections of Twin-70 Raceway at inside corners.	Off White	1	10
T702OCIW	Outside Corner Fitting. Used to join sections of Twin-70 Raceway at outside corners.	Off White	1	10
T702TIW	Tee Fitting. Used to join sections of Twin-70 Raceway at tee intersections.	Off White	1	5
T702ECIW	End Cap Fitting. Conduit breakouts of 1/2" for entry into raceway channel.	Off White	1	10
T702EEIW	Entrance End Fitting. Conduit breakouts of 1/2", 1" and 1 1/4" for entry from ceiling or wall.	Off White	1	5
T702TRIW	Transition Fitting. Used to transition to T-70 Raceway.	Off White	1	5
T702TRLIW	Transition Fitting. Used to transition to any LD Profile or T-45 Raceway.	Off White	1	5
T702TRI	Transition Divider Insert for T702 to T-70 or T702 to LD Profile. Maintains channel separation within T702TR or T702TRL fittings.	Gray	1	10

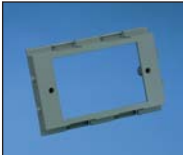
‡ For other colors replace IW (Off White) with EI (Electric Ivory) or WH (White).

Type T-70 & Twin-70 Raceway Accessories

- T-70 and Twin-70 accessories consist of device mounting brackets, snap-on device brackets, hanging boxes, and three-sided hanging boxes used to mount NEMA standard single gang electrical outlets and or communication devices

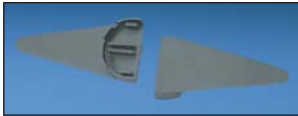
Part Number	Part Description	Color	Std. Pkg. Qty.	Std. Ctn. Qty.
 T70DB-X	 T70SDB-X			
 T70HB-X	 T70HB3-X			
 T70HB3GFCI-X	 T70WR-X			
 T70S-X				
 T70FSB				
T70DB-X	Device Mounting Bracket. Used to mount NEMA standard single gang electrical outlets and communication devices with either screw-on or snap-on single gang faceplates. Can be used with T-70, Twin-70, TE-70 and TG-70 Raceways.	Gray	10	100
T70SDB-X	Standard Faceplate Bracket. Used to mount NEMA standard single gang screw-on electrical and communication faceplates only.	Gray	10	100
T70HB-X	Hanging Box. Used to mount NEMA standard single gang electrical outlets and devices with either screw-on or snap-on single gang faceplates when there are communications cables in the raceway. For use in T-70 and Twin-70 Raceway only.	Gray	10	100
T70HB3-X	Three-sided Hanging Box. Used to mount NEMA standard single gang electrical outlets and devices with either screw-on or snap-on single gang faceplates when there are communications cables in the raceway. Box is low profile for increased channel capacity and does not require breakout removal. For use with T-70 and Twin-70 Raceway only.	Gray	10	100
T70HB3GFCI-X	T70 GFCI Three-sided Hanging Box. Accepts single gang U.S. GFCI (ground fault circuit interrupter) standard electrical devices. Provides increased internal area for connections and excess wire.	Gray	10	—
T70WR-X	Wire Retainer. Holds wires in place during installation.	Gray	10	100
T70S-X	Spacer Plate. Used to mount the CBX4 Surface Mount Box onto the T70DB-X or T70HB-X / T70HB3-X.	—	10	100
T70FSB	Fiber Spool Bracket. Each piece consists of two halves that snap into base of T-70 or Twin-70 Raceway. Provides method to contain one meter or more of fiber slack and acts as a strain relief while maintaining a minimum 30mm bend radius. Bracket separation can be adjusted to fit the length of slack required.	Gray	1	10



Use the T70FSB with T-70 or Twin-70 Raceway to contain 1m or more of fiber slack while maintaining a 30mm cable bend radius. Brackets are adjustable for slack length.



Use T70S-X Spacer Plate for mounting the CBX4 Surface Mount Box on T-70 or T702.

Quick Wire Fill Capacities for T-70 Raceway

This information is to be used as a guide in selecting the proper size raceway. The maximum amounts may vary according to the wire installation methods, straightness of wires, etc.

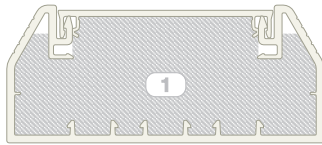

A = 5.15 in²

Wirefill #1: Raceway with no devices.

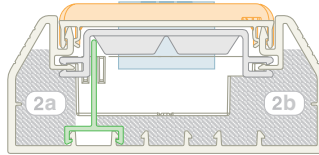

A = .86 in² A = 1.72 in²

Wirefill #2: Power and data using Three-Sided Hanging Box and Device Bracket.

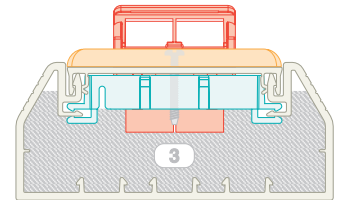

A = 3.67 in²

Wirefill #3: Data only using Vertical Sloped Screw-on Communication Faceplates.

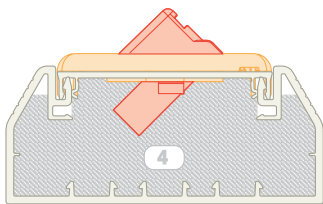

A = 4.71 in²

Wirefill #4: Data only using Horizontal Sloped Snap-on Communication Faceplates.

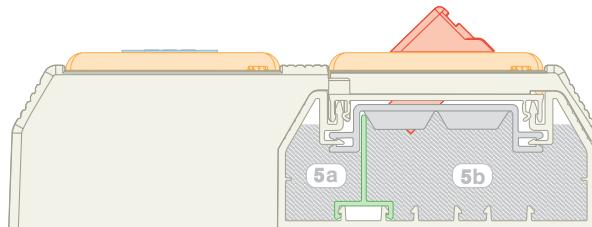

A = .91 in² A = 3.12 in²

Wirefill #5: Power and data using the *WORKSTATION OUTLET CENTER™* Offset Box.

SPEC = 40% wire fill — The recommended design in cable capacity, leaves room for future moves, adds and changes.

MAX for Data = 60% wire fill — The maximum cable quantity based on cable interweaving and packing factors.

MAX for Power wire fill — The maximum of electrical cables based on UL temperature rise test.

Raceway Type & Configuration	Fill Area (in ²)	Electrical Cables			Data Grade Cable	Data Grade Cable	Coax Cable		Fiber Optic Cable			
		14 AWG	12 AWG	10 AWG	24 AWG/UTP CM	24 AWG/UTP CM	RG6		2 Strand			
		THHN/T90			Cat 5e (4pr)	Cat 6 (4pr)	DIA. = .275		DIA. = .175			
		.105	.122	.153	DIA. = .217	DIA. = .250	DIA. = .275		DIA. = .175			
		FILL			FILL	FILL	FILL		FILL			
MAX (UL Temp Rise Test)	MAX (UL Temp Rise Test)	MAX (UL Temp Rise Test)	SPEC (40%)	MAX (60%)	SPEC (40%)	MAX (60%)	SPEC (40%)	MAX (60%)	SPEC (40%)	MAX (60%)		
1. T-70: No devices.	5.15	24	20	15	55	83	41	62	27	41	86	129
2a. T-70: Power and data using the Three-Sided Hanging Box and Device Bracket.	.86	14	11	7	9	14	7	10	5	7	14	21
	1.72	—	—	—	19	28	14	21	9	14	29	43
3. T-70: Data only (Screw-on Faceplates).	3.67	—	—	—	39	59	29	44	19	29	67	101
4. T-70: Data only (Snap-on Faceplates).	4.71	—	—	—	50	76	38	57	25	37	83	125
5a. T-70: Power and data using the WORKSTATION OUTLET CENTER™ Offset Box.	.91	14	11	7	9	14	7	11	5	7	15	23
	3.12	—	—	—	33	50	25	38	17	25	52	78

Quick Wire Fill Capacities for Twin-70 Raceway

This information is to be used as a guide in selecting the proper size raceway. The maximum amounts may vary according to the wire installation methods, straightness of wires, etc.

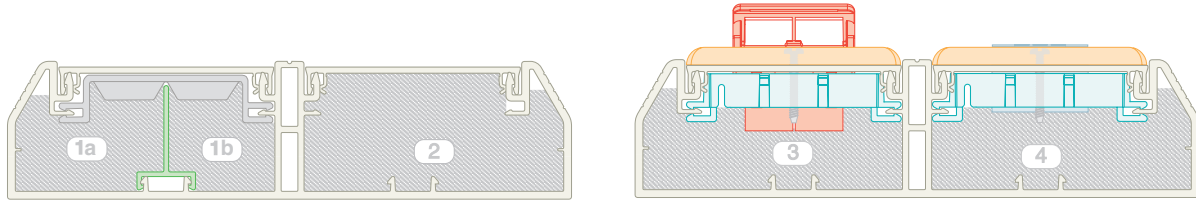

A = 2.05 in² **A = 1.43 in²** **A = 4.59 in²** **A = 3.11 in²** **A = 3.32 in²**

Wirefill #1: Power and data with no devices. **Wirefill #2:** One Twin-70 Channel with no devices. **Wirefill #3:** Data only using Vertical Sloped Screw-on Communication Faceplates. **Wirefill #4:** Power using Device Bracket and NEMA standard 70mm Screw-on faceplates.

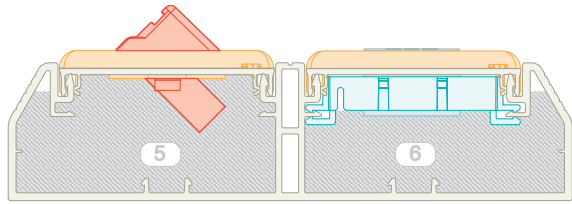

A = 4.14 in² **A = 2.33 in²**

Wirefill #5: Data only using Horizontal Sloped Snap-on Communication Faceplates. **Wirefill #6:** 20A TVSS Rectangular Outlet using Device Bracket and Snap-on Electrical/Communication Faceplate.

SPEC = 40% wire fill — The recommended design in cable capacity, leaves room for future moves, adds, and changes. **MAX for Data = 60% wire fill** — The maximum cable quantity based on cable interweaving and packing factors. **MAX for Power wire fill** — The maximum of electrical cables based on UL temperature rise test.

Raceway Type & Configuration	Fill Area (in ²)	Electrical Cables			Data Grade Cable	Data Grade Cable	Coax Cable		Fiber Optic Cable			
		14 AWG	12 AWG	10 AWG	24 AWG/UTP CM	24 AWG/UTP CM	RG6		2 Strand			
		THHN/T90			Cat 5e (4pr)	Cat 6 (4pr)	DIA. = .275		DIA. = .175			
		FILL			FILL	FILL	FILL		FILL			
		MAX	MAX	MAX	SPEC (40%)	MAX (60%)	SPEC (40%)	MAX (60%)	SPEC (40%)	MAX (60%)		
		(UL Temp Rise Test)			(40%)	(60%)	(40%)	(60%)	(40%)	(60%)		
1a.	2.05	—	—	—	22	33	16	25	18	27	34	51
1b.	1.43	—	—	—	15	23	11	17	12	19	24	36
2.	4.59	—	—	—	49	74	37	56	24	36	76	115
3.	3.11	—	—	—	33	50	25	38	16	25	52	78
4.	3.32	15	13	13	35	53	27	40	18	26	55	83
5.	4.14	—	—	—	44	67	33	50	22	33	69	103
6.	2.33	16	16	14	25	37	18	28	12	18	39	58

PAN-WAY® T-45 Non-Metallic Surface Raceway

PAN-WAY® Non-Metallic T-45 Surface Raceway is a multi-channel raceway which provides a solution for routing low voltage, fiber optic, and/or power cabling along fixed perimeter walls. T-45 Surface Raceway terminates using the T-45 Hinged Data and Power Brackets, T-45 Offset Box and select PAN-WAY® Surface Mount Outlet Boxes.

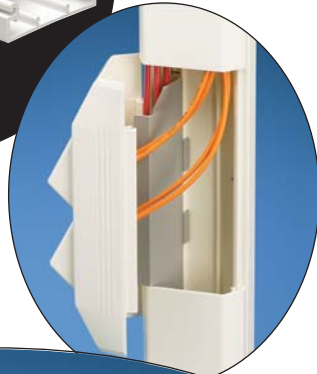
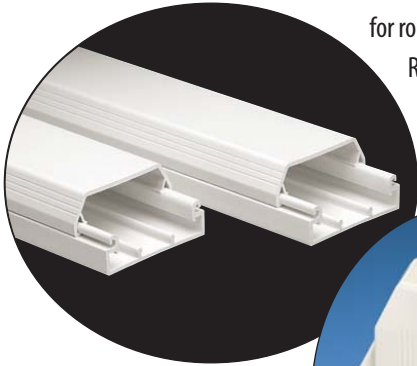

- Multi-directional cover hinge allows cable installation from either side
- Hinged data and power brackets provide easy access for terminating outlets
- Aesthetically pleasing
- Lightweight
- Tamper resistant
- Fittings maintain 1" bend radius control

PANDUIT® T-45 Surface Raceway accepts NEMA standard 70mm screw-on faceplates or superior PAN-WAY® Snap-on Faceplates when terminating with the T-45 Offset Box and Surface Mount Outlet Boxes. Fittings for T-45 are available to transition to PAN-WAY® LD Series Raceways.

T-45 Raceway Roadmap

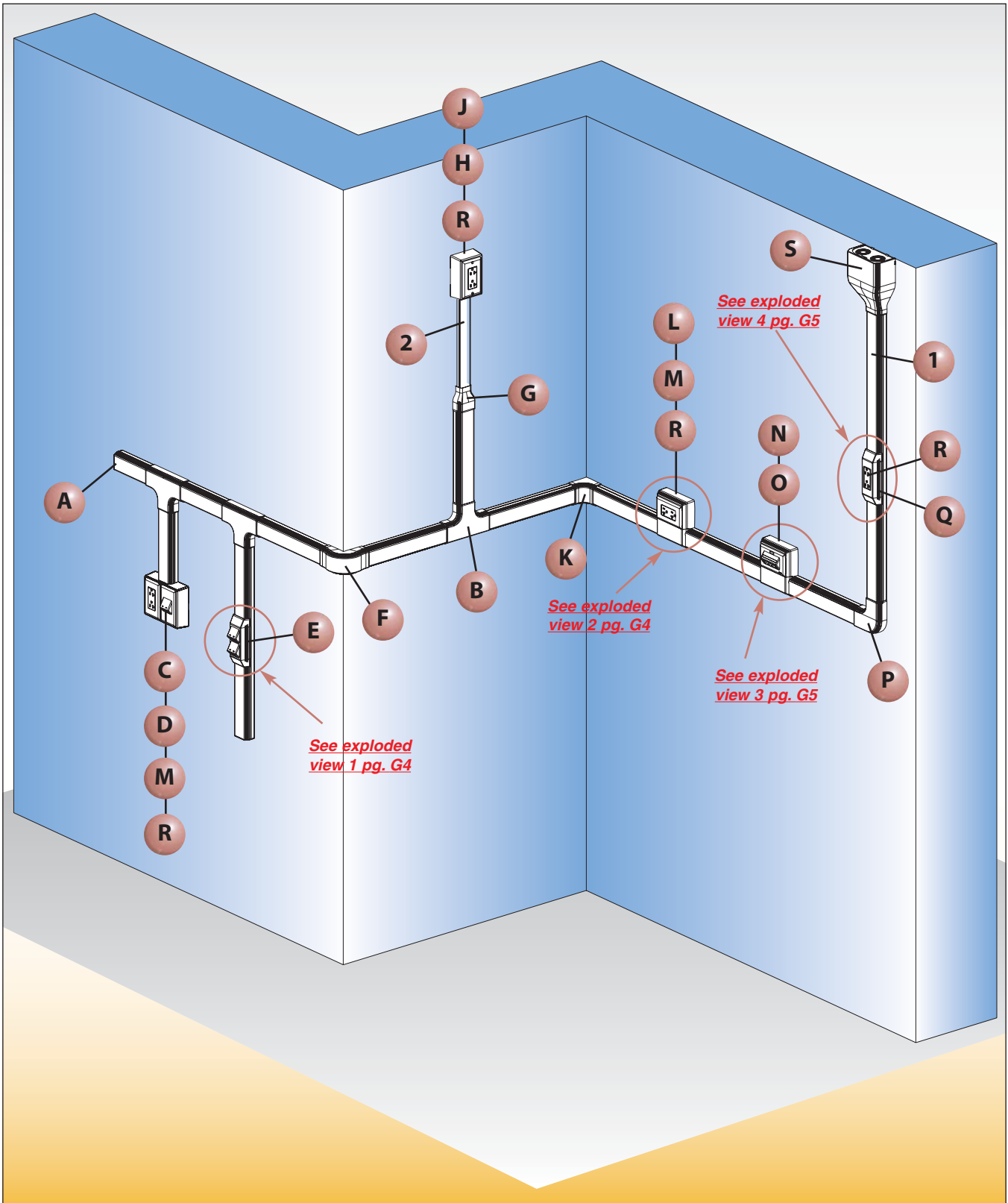

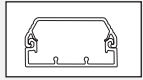

1 ***T45B*****, ***T45C***** — ***T-45 Raceway Base and Cover (page G6)***

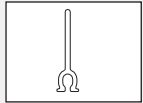

1 ***T45DW*** — ***T-45 Raceway Divider Wall (page G6)***



2 ***LDP10***** — ***LDP10 Raceway (page K15)***



A ***T45EC***** — ***T-45 End Cap Fitting (page G7)***



B ***T45T***** and ***T45TD*** — ***T-45 Tee Fitting and Divider (page G7)***

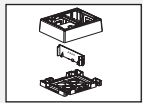

C ***JBP2FS***** — ***FAST-SNAP™ Double Gang Power Rated Surface Mount Outlet Box (page J2)***

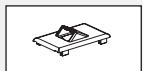

D ***T70FV2***** — ***Vertical Sloped Communication Snap-on Faceplate (page J2)***



E ***T45HDB***** — ***T-45 Snap-on Hinged Data Bracket (page G7)***



F ***T45OC***** — ***T-45 Outside Corner Fitting (page G7)***

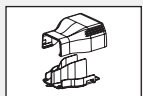

G ***T45RLD***** — ***T-45 Reducer Fitting (page G7)***



H ***JBP1***** — ***Power Rated Single Gang Two-Piece Box (page J8)***

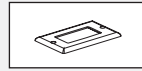

J ***CPG***** — ***Single Gang Rectangular Electrical/Communication Snap-on Faceplate (page J10)***

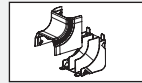

K ***T45IC***** — ***T-45 Inside Corner Fitting (page G7)***

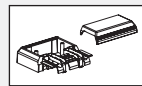

L ***T45WC***** — ***T-45 Offset Box for Screw-on Faceplates/Receptacles (page G7)***

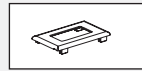

M ***T70PG***** — ***Single Gang Rectangular Electrical/Communication Snap-on Faceplate (page J3)***

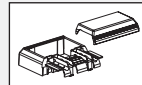

N ***T45WC2***** — ***T-45 Offset Box for Snap-on Faceplates (page G7)***



O ***UIT70FH4***** — ***ULTIMATE ID™ Sloped Horizontal Snap-on Faceplate (page H5)***

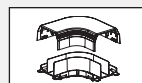

P ***T45RA***** — ***T-45 Right Angle Fitting (page G7)***



Q ***T45HEGB***** — ***T-45 Electrical Bracket (page G7)***

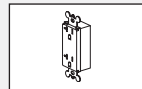

R ***ERU20***** — ***20A Rectangular Outlet (page J11)***

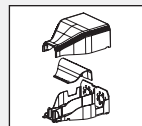

S ***T45EE***** — ***T-45 Entrance End Fitting (page G7)***

T-45 Configurations

Exploded view 1

	Components Required	See page
A.	T45HDB = T-45 Snap-on Hinged Data Bracket.	G7
B.	PAN-NET® Connectivity.	—

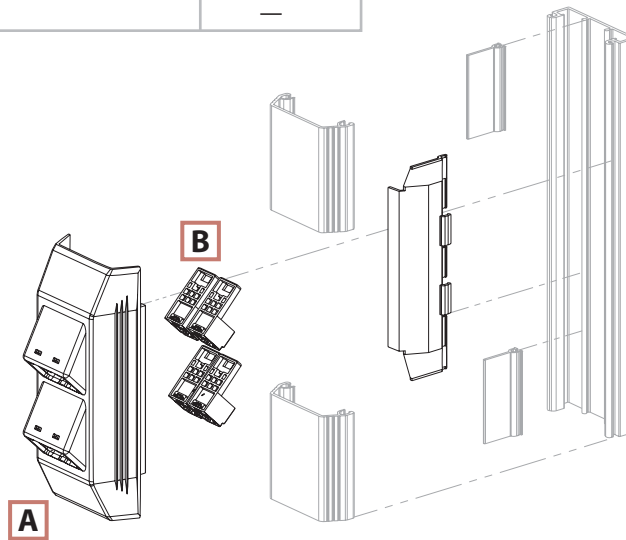

Exploded view 2

	Components Required	See page
A.	T70PG = Single Gang Rectangular Electrical/Communication Snap-on Faceplate.	J3
B.	ERU20 = 20A Rectangular Electrical Outlet (screws included).	J11
C.	T45WC = T-45 Offset Box for Screw-on Faceplates/Receptacles.	G7

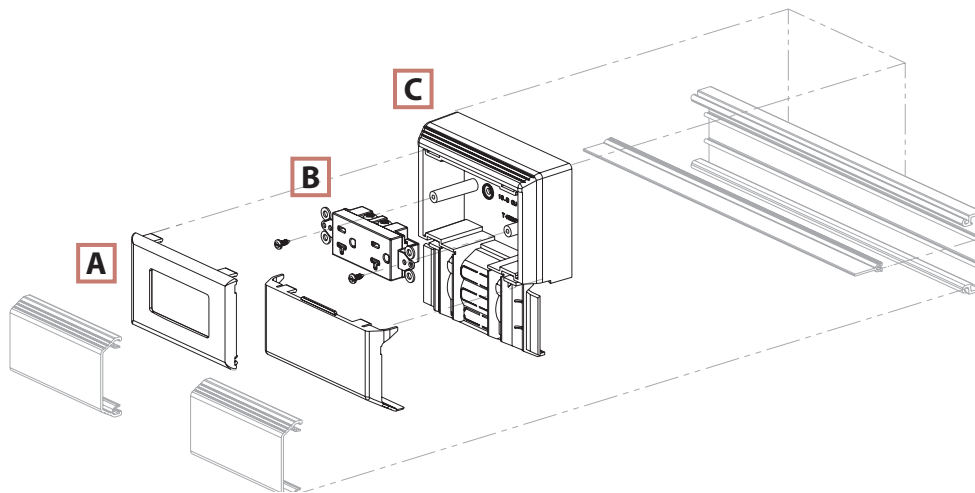

T-45 Configurations (Continued)

Exploded view 3

	Components Required	See page
A.	UIT70FH4 = <i>ULTIMATE ID™</i> Sloped Horizontal Faceplates — 4 Port.	H5
B.	<i>PAN-NET®</i> Connectivity.	—
C.	T45WC2 = T-45 Offset Box for Snap-on Faceplates.	G7

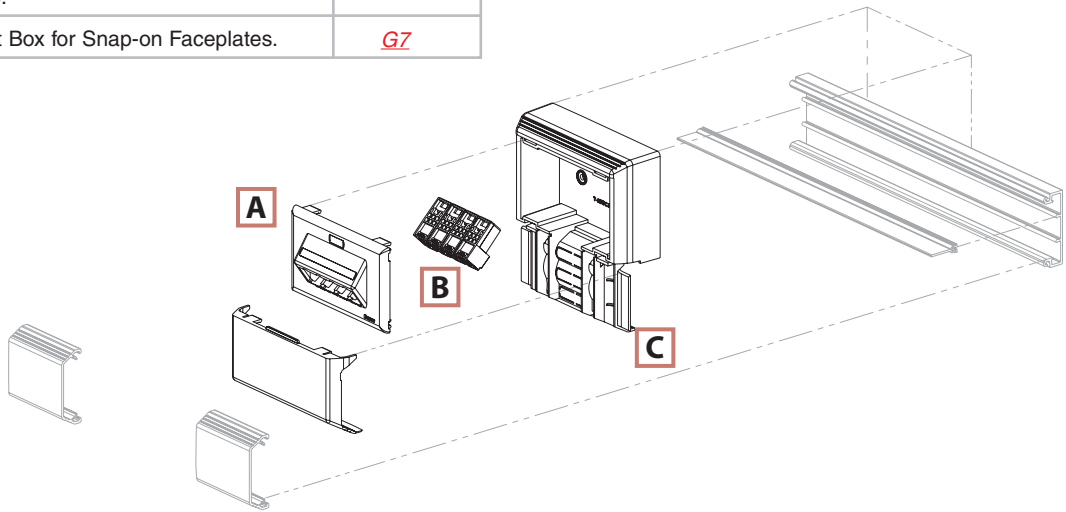

Exploded view 4

	Components Required	See page
A.	T45HEGB = T-45 Electrical Bracket for Rectangular Outlet.	G7
B.	ERU20 = 20A Rectangular Electrical Outlet (screws included).	J11

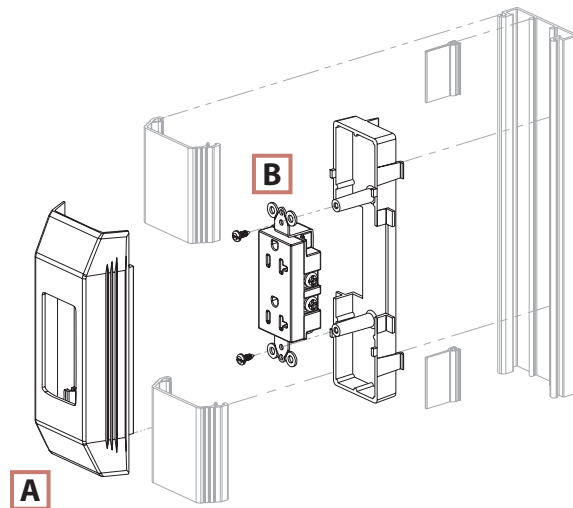

PANDUIT[®]**NON-METALLIC SURFACE RACEWAY****PAN-WAY[®] T-45 Surface Raceway System**

- UL & CSA rated 600V; meets UL5A and CSA C22.2 No. 62.1-03 standards
- Hinged cover allows easy access from either side
- Optional factory applied adhesive backing speeds installation
- Supplied with pre-punched mounting holes
- Tamper resistant
- Terminates using the T-45 Hinged Data and Power Brackets, Offset Box, or Surface Mount Outlet Box solutions

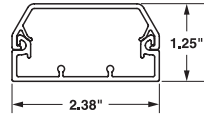

Internal Area = 2.12 Sq. In.

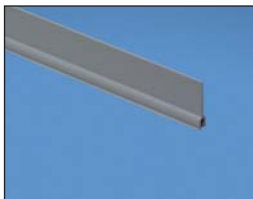















**T45B****T45C****T45DW**

Part Number	Part Description	Raceway Size	Color‡	Length (ft)	Std. Ctn. Qty.
T-45 Raceway Base with adhesive					
T45BIW8-A	T-45 Raceway Base in 8' and 10' lengths with adhesive. Supplied with pre-punched mounting holes.	2.38" x 1.25"	Off White	8	160
T45BIW10-A		2.38" x 1.25"		10	200
T-45 System Benefits					
T45BIW8	T-45 Raceway Base in 8' and 10' lengths. Supplied with pre-punched mounting holes.	—	Off White	8	160
T45BIW10				10	200
T-45 Raceway Cover					
T45CIW8	T-45 Raceway Cover in 8' and 10' lengths. Can be hinged open on either side of T-45 Base.	—	Off White	8	160
T45CIW10				10	200
T-45 Raceway Divider Wall					
T45DW8	T-45 Divider Wall. Snaps onto rails in T-45 Raceway Base to create separate channels. Must use wire retainers to ensure channel separation per UL/CSA. Available in 8' and 10' lengths.	—	Gray	8	160
T45DW10				10	200

‡ For other colors replace IW (Off White) with EI (Electric Ivory).
Order base and cover separately.
Order number of feet required in multiples of standard carton quantity.

UL **SF** **PAN-WAY® Type T-45 Fittings**

- T-45 fittings are designed to maintain the TIA/EIA 568-B and 569-B required minimum bend radius for high performance copper and fiber optic cabling systems

Part Number	Part Description	Color	Std. Pkg. Qty.	Std. Ctn. Qty.
 T45CC	 T45RA	T45CCIW-X	10	100
 T45IC	 T45OC			
 T45T	 T45TD	T45TIW	1	10
 T45EC	 T45EE			
 T45RLD	 T45TRI	T45HDBIW*	1	10
 T45HDB	 T45HEB			
 T45HEGB	 T45WR-X	T45WC1W	1	10
 T45WC	 T45WC2			

‡ For other colors replace IW (Off White) with EI (Electric Ivory). T45TD, T45TRI, and T45WR-X available in Gray only.

* For complete labeling solutions and product information, [reference chart on page J17](#).

Quick Wire Fill Capacities for T-45 Raceway

This information is to be used as a guide in selecting the proper size raceway. The maximum amounts may vary according to the wire installation methods, straightness of wires, etc.



A = 2.13 in²

Wirefill #1: T-45 with no devices.

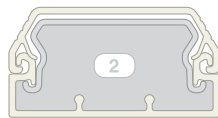

A = 1.72 in²

Wirefill #2: T-45 with wire retainer.

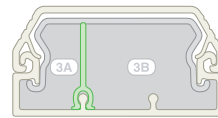

A = .44 in²

B = 1.20 in²

Wirefill #3: Power and data using a Wire Retainer and Divider Wall.

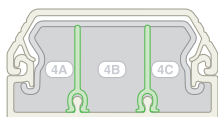

A = .44 in²

B = .68 in²

C = .44 in²

Wirefill #4: Power and data using a Wire Retainer and Divider Walls.

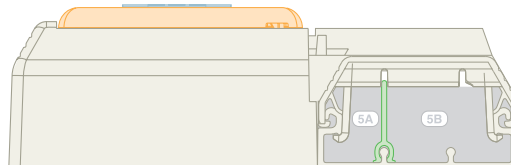

A = .41 in²

B = 1.06 in²

Wirefill #5: Power and data using the Offset Box.

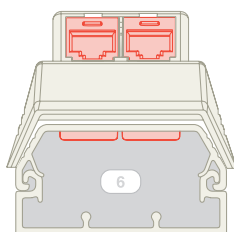

A = 2.00 in²

Wirefill #6: Data only using Hinged Data Bracket.

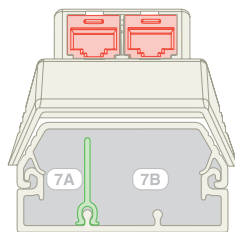

A = .52 in²

B = 1.2 in²

Wirefill #7: Power and data using Hinged Data Bracket with Divider Insert.

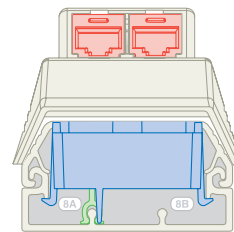

A = .22 in²

B = .5 in²

Wirefill #8: Power and data using Electrical Bracket/Box and Hinged Data Bracket.

SPEC = 40% wire fill — The recommended design in cable capacity, leaves room for future moves, adds, and changes.

MAX for Data = 60% wire fill — The maximum cable quantity based on cable interweaving and packing factors.

MAX for Power wire fill — The maximum of electrical cables based on UL temperature rise test.

Raceway Type & Configuration	Fill Area (in ²)	Electrical Cables			Data Grade Cable	Data Grade Cable	Coax Cable		Fiber Optic Cable			
		14 AWG	12 AWG	10 AWG	24 AWG/UTP CM	24 AWG/UTP CM	RG6		2 Strand			
		THHN/T90			Cat 5e (4pr)		Cat 6 (4pr)		DIA. = .275		DIA. = .175	
		.105	.122	.153	DIA. = .217		DIA. = .250		DIA. = .275		DIA. = .175	
MAX		MAX	MAX	SPEC	MAX	SPEC	MAX	SPEC	MAX	SPEC	MAX	
(UL Temp Rise Test)				(40%)	(60%)	(40%)	(60%)	(40%)	(60%)	(40%)	(60%)	
1. T-45: No devices.	2.13	36	27	25	22	34	17	26	11	17	35	53
2. T-45: No devices with wire retainer.	1.72	36	27	25	18	27	14	21	9	14	28	42
3A. T-45: Power and data with wire retainer & divider wall (2 channels).	.44	12	11	8	4	7	3	5	2	3	7	10
	1.20	—	—	—	12	19	9	14	6	10	16	29
	.44	12	11	8	4	7	3	5	2	3	7	10
4A. T-45: Power and data with wire retainer & two divider walls (3 channels).	.44	12	11	8	4	7	3	5	2	3	7	10
	.68	—	—	—	7	11	5	8	4	5	11	16
4C. T-45: Power and data with wire retainer & two divider walls (3 channels).	.44	—	—	—	4	7	3	5	2	3	7	10
5A. T-45: Power and data using the WORKSTATION OUTLET CENTER™ Offset Box.	.41	12	11	8	4	6	3	5	2	3	6	10
	1.06	—	—	—	11	17	8	12	6	8	17	26
6. T-45: Data only using data bracket.	2.00	—	—	—	21	32	16	24	11	16	33	49
7A. T-45 Power and data using Hinged Data Bracket with Divider Insert.	.52	12	11	8	—	—	—	—	3	4	—	—
	1.2	—	—	—	12	18	9	14	6	10	16	24
8A. T-45: Power and data using Electrical Bracket and Box.	.22	9	7	4	—	—	—	—	1	2	—	—
	.5	—	—	—	5	8	4	6	3	4	8	12

ULTIMATE ID™ NETWORK LABELING SYSTEM FOR OUTLETS

Permanent labeling is critical for all network cabling system installations. The TIA/EIA-606-A standard has created a unified system that specifies a “common” method of labeling the complete telecommunication infrastructure. PANDUIT® offers the *ULTIMATE ID™* System that supports standard compliant installations and provides a clear and efficient way to label network components according to the TIA/EIA-606-A standard. The *ULTIMATE ID™* System saves time and money with a common label height across all *ULTIMATE ID™* System products. The fewer the components, the more cost effective the system.

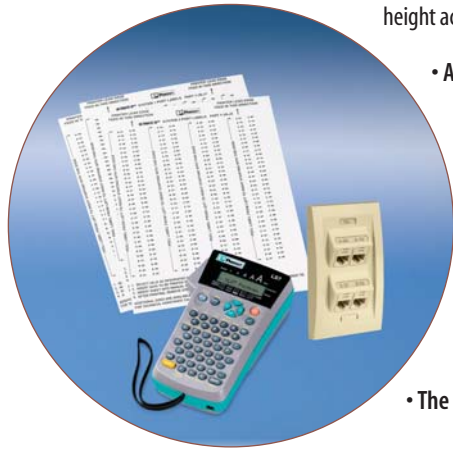

- All labels are protected by a transparent plastic cover
- All labels are positioned adjacent to, centered and parallel to the port they are identifying
- All labels have the same compact height to enhance the appearance of the installation
- All labels are made of a durable, multi-layered, non-adhesive construction that makes installation and removal quick and easy
- The label cover surface is flush with the adjacent faceplate surface

To maximize legibility, the TIA/EIA-606-A standard stated that all labels should be printed or generated by a “mechanical” device. *ULTIMATE ID™* labeling solutions are available for a variety of printers, including desktop, as well as the PANDUIT® PANAĀEA® LS7 Hand-held Thermal Transfer Printer. The PANAĀEA® LS7 Printer makes compliant labeling fast and easy. Built-on programming lets you line up your legends on patch panel and faceplate labels without guessing how many spaces are needed, which make the PANAĀEA® LS7 Printer the best solution for on-site connectivity labeling.

The *ULTIMATE ID™* Faceplates are available in executive series, classis series and snap-on style for use with PANDUIT® Raceway and accept all *MINI-COM®* Modules for multi-media applications.

How *ULTIMATE ID™* Network Labeling System for Outlets (Faceplates) assists in compliance with TIA/EIA-606-A Standard.

Section 5.1.2 States

A horizontal link identifier, unique within the building, shall be assigned to each horizontal link and to its elements.

In the work area, each individual telecommunications outlet/connector shall be labeled with the horizontal link identifier. The labeling shall appear on the connector, faceplate, or MUTOA, in a way that clearly identifies the individual connector associated with the particular identifier. A horizontal link identifier shall have a format of “fs-an” where:

- f** = numeric character(s) identifying the floor of the building occupied by the TS (telecommunications space)
- s** = alpha character(s) uniquely identifying the TS on floor f, or the building area in which the space is located
- a** = one to two alpha characters uniquely identifying a single patch panel, a group of patch panels with sequentially numbered ports, an IDC connector, or a group of IDC connectors, serving as part of the horizontal cross-connect
- n** = two to four numeric characters designating the port on a patch panel in the TS

Each *ULTIMATE ID™* Faceplate is designed in a way that allows one to center the “an” identifier clearly over each outlet/connector, while the “fs” identifier can be placed in the station space.

Selection Chart for using *PAN-WAY*® Surface Raceway with *ULTIMATE ID*™ Faceplates

How to use this chart:

1. Locate the desired raceway in the left-hand column.
2. Locate the desired *ULTIMATE ID*™ Faceplate in the top row.
3. Match up the raceway with the faceplate to identify the mounting options.



Executive Series Faceplates

Screw Mount Faceplates
page H3-H4



Classic Series Faceplates



Sloped Snap-on Faceplates

Snap-on Faceplates
page H5

		Executive Series Faceplates	Classic Series Faceplates	Sloped Snap-on Faceplates
Office Furniture		Screw mount faceplate directly to OFCR70 Corner Channel with the use of T70SDB-X Device Bracket located on page C8 , or use OFR20DMB Desk Mount Box located on page C7 .		Faceplates snaps into OFCR70 Corner Channel Base or use OFR20DMB Desk Mount Box located on page C7 .
Cove		Use WCM35DBFIW (Device Box and Faceplate Adapter).		Use WCM35DBFIW (Device Box and Faceplate Adapter).
TG-70		Screw mount faceplate directly to channel with the use of a T70DB-X Device Bracket located on page E8 .		Faceplate snaps into raceway channel.
T-70		Screw mount faceplate directly to channel with the use of a T70DB-X Device Bracket, located on page F12 or use T70WC WORKSTATION OUTLET CENTER™ Offset Box located on page F9 .		Faceplates snaps into raceway channel or use T70WC2 WORKSTATION OUTLET CENTER™ located on page F9 .
Twin-70		Screw mount faceplate directly to channel with the use of a T70DB-X Device Bracket located on page F12 .		Faceplate snaps into raceway channel.
T-45		Use <i>PAN-WAY</i> ® Low Voltage or Power Rated Surface Mount Outlet Boxes located on page J7 and page J8 or use T45WC Offset Box located on page G7 .		Use JB1FS or JBP2FS Surface Mount Outlet Boxes located on page J2 or use T45WC2 Offset Box located on page G7 .
LD2P10		Use JBP1 or JBP1D Surface Mount Outlet Box with JBD1 pass through divider located on page J7 and page J8 .		Use JBP2FS Surface Mount Outlet Box located on page J2 .
LD		Use <i>PAN-WAY</i> ® Low Voltage Surface Mount Outlet Boxes located on page J7 and page J8 .		Use JB1FS Surface Mount Outlet Box located on page J2 .
LDP		Use <i>PAN-WAY</i> ® Low Voltage or Power Rated Surface Mount Outlet Boxes located on page J7 and page J8 .		Use JB1FS Surface Mount Outlet Box located on page J2 .
LDS		Use <i>PAN-WAY</i> ® Low Voltage or Power Rated Surface Mount Outlet Boxes located on page J7 and page J8 .		Use JB1FS Surface Mount Outlet Box located on page J2 .
T-130		Screw mount faceplate directly to channel with the use of a TB5583-V Outlet Box located on page L7 .		Not applicable.
<i>PAN-POLE</i> ™ Outlet Pole		Screw mount faceplate directly to channel with the use of a T70SDB-X Device Bracket located on page M4 .		Faceplate snaps into channel.



MINI-COM® ULTIMATE ID™ Executive Series Faceplates

- Designed to efficiently support TIA/EIA-606-A standard labeling requirements
- Accept *MINI-COM*® Modules for STP and UTP (including Category 5e and Category 6), Fiber Optic and Coax, which snap in and out for easy moves, adds and changes
- Supplied with color coordinated screw cover and clear station and port label covers, labels sold separately
- Can be clearly identified with the *PANAĀEA*® LS7 Hand-held Thermal Transfer Printer
- Computer printable label sheets for desktop printers and write-on labels available
- Replacement screw covers and label covers available
- Optional icons available



UICFPSE2



UICFPSE4



UICFPSE6



UICFPHSE2



UICFPHSE4

Part Number	Part Description	Labels Required	Color†	Std. Pkg. Qty.	Std. Ctn. Qty.
UICFPSE2IW	Single gang, vertical sloped faceplate holds up to two <i>MINI-COM</i> ® Modules.	1-One Port 1-Two Port	Off White	1	10
UICFPSE4IW	Single gang, vertical sloped faceplate holds up to four <i>MINI-COM</i> ® Modules.	1-One Port 2-Two Port	Off White	1	10
UICFPSE6IW	Single gang, vertical sloped faceplate holds up to six <i>MINI-COM</i> ® Modules. Requires min. 1.9" wide in wall box or wallboard adapter for proper installation.	1-One Port 2-Three Port	Off White	1	10
UICFPHSE2IW	Single gang, horizontal sloped faceplate holds up to two <i>MINI-COM</i> ® Modules.	1-One Port 1-Two Port	Off White	1	10
UICFPHSE4IW	Single gang, horizontal sloped faceplate holds up to four <i>MINI-COM</i> ® Modules.	1-One Port 1-Four Port	Off White	1	10

† For other colors replace suffix IW (Off White) with EI (Electric Ivory) or WH (White).
All faceplates supplied with mounting screws.
Computer printable labels found on [page H8](#).

System Overview

Quick Selection Guide

Office Furniture

Cove

TG-70

T-70 & Twin-70

T-45

Ultimate ID System

Faceplates, Boxes & Labeling

LD Profile

T130

Outlet Pole

Technical Info

Index

PANDUIT[®]**NON-METALLIC SURFACE RACEWAY****MINI-COM[®] ULTIMATE ID[™] Classic Series Faceplates**

- Designed to efficiently support TIA/EIA-606-A standard labeling requirements
- Accept *MINI-COM[®]* Modules for STP and UTP (including Category 5e and Category 6), Fiber Optic and Coax, which snap in and out for easy moves, adds and changes
- Supplied with color coordinated screw cover and clear station and port label covers, labels sold separately
- Can be clearly identified with the *PANACEA[®]* LS7 Hand-held Thermal Transfer Printer
- Computer printable label sheets for desktop printers and write-on labels available
- Replacement screw covers and label covers available
- Optional icons available

**UICFP2****UICFP4****UICFP6****UICFP2****UICFP4**

Part Number	Part Description	Labels Required	Color‡	Std. Pkg. Qty.	Std. Ctn. Qty.
UICFP2IW	Single gang, vertical faceplate holds up to two <i>MINI-COM[®]</i> Modules.	1-One Port 1-Two Port	Off White	1	10
UICFP4IW	Single gang, vertical faceplate holds up to four <i>MINI-COM[®]</i> Modules.	1-One Port 2-Two Port	Off White	1	10
UICFP6IW	Single gang, vertical faceplate holds up to six <i>MINI-COM[®]</i> Modules. Requires min. 1.9" wide in wall box or wallboard adapter for proper installation.	1-One Port 2-Three Port	Off White	1	10
UICFP2IW	Single gang, horizontal faceplate holds up to two <i>MINI-COM[®]</i> Modules.	1-One Port 1-Two Port	Off White	1	10
UICFP4IW	Single gang, horizontal faceplate holds up to four <i>MINI-COM[®]</i> Modules.	1-One Port 1-Four Port	Off White	1	10

‡ For other colors replace IW (Off White) with EI (Electric Ivory) or WH (White).
All faceplates supplied with mounting screws.
Computer printable labels found on [page H8](#).



MINI-COM® ULTIMATE ID™ Sloped Snap-On Faceplates

- Designed to efficiently support TIA/EIA-606-A standard labeling requirements
- For use with PANDUIT® Raceways*: LD, T-45, T-70, Twin-70, TG-70, TE-70, Cove, PAN-POLE™ Outlet Pole and FAST-SNAP™ Outlet Boxes
- Snap into raceway channel or outlet box and requires no additional mounting hardware or adapters — greatly reducing installation time
- Meet stringent UL5A standard for non-metallic raceways
- Accept MINI-COM® Modules for STP and UTP (including Category 5e and Category 6), Fiber Optic and Coax, which snap in and out for easy moves, adds and changes
- Can be clearly identified with the PANACEA® LS7 Hand-held Thermal Transfer Printer
- Computer printable label sheets for desktop printers and write-on labels available
- Supplied with clear station and port label covers, labels sold separately
- Replacement label covers available
- Optional icons available



Part Number	Part Description	Labels Required	Color‡	Std. Pkg. Qty.	Std. Ctn. Qty.
UIT70FH2IW	Single gang, horizontal sloped communication snap-on faceplate accepts up to two MINI-COM® Modules.	1-One Port 1-Two Port	Off White	1	10
UIT70FH4IW	Single gang, horizontal sloped communication snap-on faceplate accepts up to four MINI-COM® Modules.	1-One Port 1-Four Port	Off White	1	10
UIT70FV2IW	Single gang, vertical sloped communication snap-on faceplate accepts up to two MINI-COM® Modules.	1-One Port 1-Two Port	Off White	1	10
UIT70FV4IW	Single gang, vertical sloped communication snap-on faceplate accepts up to four MINI-COM® Modules.	1-One Port 2-Two Port	Off White	1	10

‡ For other colors replace suffix IW (Off White) with EI (Electric Ivory), WH (White) or IG (International Gray).
Computer printable labels found on [page H8](#).

PANDUIT®

NON-METALLIC SURFACE RACEWAY

ULTIMATE ID™ Network Labeling System Identification Products

A world leader in identification solutions, PANDUIT® designs and manufactures labeling products, software and printers to assist you with TIA/EIA-606-A compliance. The PANDUIT® ULTIMATE ID™ system includes a full line of TIA/EIA-606-A standard compliant labeling products for network cabling identification from the point of building entry to the workstation. Properly identifying your network allows moves, adds, changes, troubleshooting and repairs to be accomplished faster and more efficiently.



How ULTIMATE ID™ Network Labeling System, PANAĀEA® LS7 Hand-held Thermal Transfer Printer and Laser/Ink Jet Labels assist in compliance with the TIA/EIA-606-A Standard.

Section 10.1. States

The size, color, and contrast of all labels should be selected to ensure that the identifiers are easily read. Labels should be visible during the installation of and normal maintenance of the infrastructure. Labels should be resistant to the environmental conditions at the point of installation (such as moisture or heat), and should have a design life equal to or greater than that of the labeled component.

Section 10.2 States

To maximize legibility, all labels shall be printed or generated by a mechanical device.

PANDUIT® label materials for the PANAĀEA® LS7 Hand-held Thermal Transfer Printer as well as Laser/Ink Jet products are generated by a mechanical device and are made of durable polymer construction that will withstand the effects of moisture, heat and time.

PANAĀEA® LS7 Hand-Held Thermal Transfer Printer and Label Cassettes

- Multi-purpose printer supports *ULTIMATE ID™* System and additional network labeling requirements. For detailed printing instructions to create *ULTIMATE ID™* labels using the *PANAĀEA®* LS7 printer, request SA-IDSP01
- High quality thermal transfer print for professional looking labels that will not smear
- Fast loading label cassette includes both label material and ribbon to make changing labels easy
- No more spacing and guess work – length function aligns legends with ports
- Advanced functions including serialization, vertical and horizontal lines, symbol library and memory
- Six AA alkaline batteries and hardside case included



LS7

Part Number	Part Description	Std. Pkg. Qty.	Std. Ctn. Qty.
LS7	Printer Kit (includes printer, 3/4" (18mm) non-laminated black/white cassette, hardside carrying case, wrist strap, 6 AA alkaline batteries, label separator tool and operator's manual).	1	4
LS7-ACS	120 VAC adapter*	1	6
LS7-CLN	Cleaning cassette	1	20

*Cannot be used to charge batteries.

For a full product offering of the *PANAĀEA®* LS7 Hand-Held Printer, request product bulletin SA-IDCB1000A.

Component Cassettes for PANAĀEA® LS7 Hand-Held Thermal Transfer Printer

Part Number	Part Description	Height		Length		Std. Pkg. Qty.*	Std. Ctn. Qty.
		In.	mm	ft.	M		
UMLS7BW	Black/white non-laminated polyester label cassette.	.236	6.0	26.2	8.0	1	20

ULTIMATE ID™ Non-Laminated Label Cassette

For use with *ULTIMATE ID™* System applications.

Laminated Adhesive Label Cassettes

For flat label applications only.

LS7-25-1^	Black/white laminated polyester label cassette.	.236	6.0	26.2	8.0	1	20
LS7-25-2	Black/clear laminated polyester label cassette.	.236	6.0	26.2	8.0	1	20
LS7-38-1‡	Black/white laminated polyester label cassette.	.354	9.0	26.2	8.0	1	20
LS7-38-2	Black/clear laminated polyester label cassette.	.354	9.0	26.2	8.0	1	20
LS7-50-1	Black/white laminated polyester label cassette.	.472	12.0	26.2	8.0	1	20
LS7-50-2	Black/clear laminated polyester label cassette.	.472	12.0	26.2	8.0	1	20

*Order number of cassettes required in multiples of Std. Pkg. Qty.

Cable Marking Cassettes for PANAĀEA® LS7 Hand-Held Thermal Transfer Printer

Part Number	Part Description	Width		Length		Std. Pkg. Qty.*	Std. Ctn. Qty.
		In.	mm	ft.	M		
LS7-75NL-1	Black/white non-laminated polyester continuous label cassette.	.708	17.98	26.2	8.0	1	20
LS7-75NL-2	Black/clear non-laminated polyester label cassette.	.708	17.98	26.2	8.0	1	20

Non-Laminated Adhesive Label Cassettes

For cable identification and flat label applications.

^ Faceplates and patch panels which are not part of the *ULTIMATE ID™* Network Labeling System can be identified by utilizing the LS7-25-1 label cassette as an adhesive label.

‡ Non-*ULTIMATE ID™* faceplates which accept .4 inch high labels can be identified by utilizing the LS7-38-1 label cassette as a non-adhesive label.

All LS7 label cassettes contain 26.2 feet of label material.

For non-adhesive labeling solution, do not remove liner from label.

*Order number of cassettes required in multiples of Std. Pkg. Qty.



PANDUIT[®]**NON-METALLIC SURFACE RACEWAY****ULTIMATE ID™ Laser/Ink Jet Labels**

- Designed to efficiently support TIA/EIA-606-A standard labeling requirements
- Laser/Ink Jet labels for use with *ULTIMATE ID™* faceplates, patch panels, marker ties, modular furniture faceplate and surface mount boxes
- Durable multilayer construction
- Each standard package contains five 8.5" x 11" sheets
- Non-adhesive labels are easily removed from label sheets
- Unique die-cut non-adhesive material configuration leaves no exposed adhesive remains on sheets after labels are removed
- Available in White and Electrical Ivory

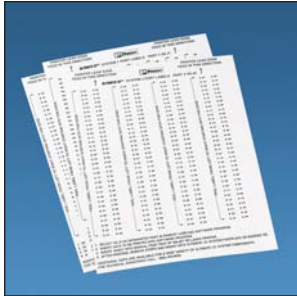

Part Number‡	Part Description	Width		Height		Std. Pkg. Qty.*	Std. Ctn. Qty.
		In.	mm	In.	mm		
UILJ1	One port, white non-adhesive polyester labels, 264 per sheet.	.680	17.27	.236	5.99	5	50
UILJ2	Two port, white non-adhesive polyester labels, 132 per sheet.	1.315	33.40	.236	5.99	5	50
UILJ3	Three port, white non-adhesive polyester labels, 99 per sheet.	1.950	49.53	.236	5.99	5	50
UILJ4	Four port, white non-adhesive polyester labels, 66 per sheet.	2.585	65.66	.236	5.99	5	50
UILJ6	Six port, white non-adhesive polyester labels, 66 per sheet.	3.855	97.92	.236	5.99	5	50
UILJCOMBO	Combination sheet with 40 one port, 60 two port, 3 three port and 24 four port, white non-adhesive polyester labels per page.	—	—	.236	5.99	5	50

‡ For Electrical Ivory labels, add EI to end of part number.

*Order number of sheets required in multiples of Std. Pkg. Qty.

ULTIMATE ID™ Labeling Software for WINDOWS^

- Fast and easy creation of labels for *ULTIMATE ID™* Network Labeling System patch panels, faceplates, surface mount boxes, and marker ties
- Create alpha and numeric serializations
- ODBC (Open Data-Base Connectivity) allows importing of information from electronic databases such as EXCEL^ and ACCESS^ directly onto the label formats
- *ULTIMATE ID™* System formats are preloaded and ready to use
- On-line help function files, including the TIA/EIA-606-A Labeling Compliance Brochure that assists in understanding the TIA/EIA-606-A standard and insure network labeling compliance
- Easy to install and supplied on CD-ROM
- Image library that includes commonly used symbols for fax, data and voice
- Automatically aligns legends with ports on patch panels and faceplates
- Vertical line function enables users to separate legends
- Automatic font sizing
- Supports most WINDOWS^ printer drivers and is compatible with standard desktop laser and ink jet printers

System Requirements:

- WINDOWS^ 95, 98, Me, 2000, NT 4.x, and XP; minimum 486 processor; minimum 10MB of RAM; 30 MB hard drive space

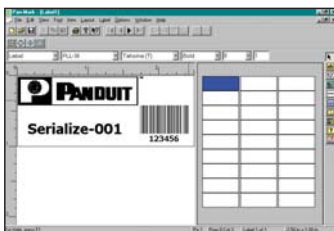

Part Number	Part Description	Std. Pkg. Qty.	Std. Ctn. Qty.
UISW	WINDOWS^ labeling software, CD-ROM, Compatible with WINDOWS^ 95, 98, Me, 2000, NT 4.x and XP.	1	10

^WINDOWS, EXCEL and ACCESS are registered trademarks of Microsoft Corp. in the United States and other countries.

PAN-MARK® for WINDOWS^ Labeling Software

- PAN-MARK® for WINDOWS^ Labeling Software has preloaded and ready to use thermal transfer, dot-matrix, laser and ink jet label formats, including *ULTIMATE ID™* System formats
- ODBC (Open Data-Base Connectivity) allows importing of information from electronic databases such as EXCEL^ and ACCESS^ directly onto the label formats
- On-line help function files, including the TIA/EIA-606-A Labeling Compliance Brochure that assists in understanding the TIA/EIA-606-A standard and insure network labeling compliance
- Easy to install and supplied on CD-ROM

- Uses full range of WINDOWS^ fonts including True Type* fonts
- Use image library to add commonly used symbols to your labels (fax, data, voice, etc.)
- Import bitmap (.bmp) graphic images into a label
- Create alpha and numeric serializations

System Requirements:

- WINDOWS^ 95, 98, Me, 2000, NT 4.x, and XP; minimum 486 processor; minimum 8MB of RAM; 30 MB hard drive space

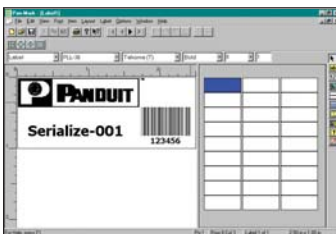

Part Number	Part Description	Std. Pkg. Qty.	Std. Ctn. Qty.
PROG-WIN2CD	WINDOWS^ labeling software, CD-ROM, Compatible with WINDOWS^ 95, 98, Me, 2000, NT 4.x and XP.	1	10

For detailed information on PAN-MARK® for WINDOWS^ Labeling Software, request product bulletin SA-IDCB1043A.

^ WINDOWS, EXCEL and ACCESS are registered trademarks of Microsoft Corp. in the United States and other countries.

*True Type is a registered trademark of Apple Computing.

ULTIMATE ID™ Write-On Labels

- Write-on labels for use with *ULTIMATE ID™* faceplates, surface mount boxes and patch panels



UIWOL2

Part Number	Part Description	Width		Height		Std. Pkg. Qty.	Std. Ctn. Qty.
		In.	mm	In.	mm		
UIWOL1-L	One port, white non-adhesive polyester write-on label.	.680	17.3	.236	5.99	50	250
UIWOL2-L	Two port, white non-adhesive polyester write-on label.	1.315	26.7	.236	5.99	50	250
UIWOL3-L	Three port, white non-adhesive polyester write-on label.	1.950	27.4	.236	5.99	50	250
UIWOL4-L	Four port, white non-adhesive polyester write-on label.	2.585	65.6	.236	5.99	50	250
UIWOL6-L	Six port, white non-adhesive polyester write-on label.	3.855	97.9	.236	5.99	50	250

The TIA/EIA-606-A standard states that all labels shall be mechanically generated, write-on labels are not standard compliant.

*Order number of labels required in multiples of Std. Pkg. Qty.

PANDUIT[®]**NON-METALLIC SURFACE RACEWAY****Permanent Marking Pens**

- Fast drying permanent ink
- Can be used with write-on labels on page H9



Part Number	Part Description	Color	Std. Pkg. Qty.	Std. Ctn. Qty.
PFX-0	Permanent Marking Pen.	Black	12	144
PFX-2	Permanent Marking Pen.	Red	12	144

The TIA/EIA-606-A standard states that all labels shall be mechanically generated. Write-on labels are not standard compliant.

ULTIMATE ID™ Replacement Label Covers and Screw Covers

- For use with *ULTIMATE ID™* faceplates, patch panels, hook & loop marker ties and surface mount boxes



Part Number	Part Description	Color‡	Std. Pkg. Qty.	Std. Ctn. Qty.
UILC1CL-X	One port label or screw cover.	Clear	10	100
UILC2CL-X	Two port label cover.	Clear	10	100
UILC3CL-X	Three port label cover.	Clear	10	100
UILC4CL-X	Four port label cover.	Clear	10	100
UILC6CL-X	Six port label cover.	Clear	10	100

‡ For other colors replace suffix CL (Clear) in part number with appropriate color suffix to match *ULTIMATE ID™* component.

ULTIMATE ID™ Icons

- Provide port identification of data and voice applications
- Snap into *ULTIMATE ID™* surface mount boxes and work area faceplates



Part Number	Part Description	Color‡	Std. Pkg. Qty.	Std. Ctn. Qty.
UICIDIW-C	Plastic snap-in icon with data image.	Off White	100	1000
UICIPW-C	Plastic snap-in icon with phone image.	Off White	100	1000

‡ For other colors replace suffix IW (Off White) with EI (Electric Ivory), WH (White), IG (International Gray), BL (Black), OR (Orange), RD (Red), BU (Blue), GR (Green), YL (Yellow) or VL (Violet).
ULTIMATE ID™ icons are not TIA/EIA-606-A standard compliant.

PAN-WAY® FACEPLATES AND SURFACE MOUNT OUTLET BOXES

PAN-WAY® Snap-on Faceplates are designed for use with PANDUIT® Raceway Systems. They install faster than conventional screw-on faceplates, reducing labor costs and provide a more aesthetic appearance. PAN-WAY® Snap-on Communication Faceplates are available in vertical and horizontal orientation and accept MINI-COM® Copper and Fiber Optic Modules. Electrical outlets are available in colors to complement PANDUIT® Raceway Systems and are available in 20A, 106 Duplex, Rectangular, TVSS and GFCI.



- PAN-WAY® Snap-on Faceplates install without the use of screws providing faster installation and superior aesthetics
- PAN-WAY® FAST-SNAP™ Boxes assemble without the use of screws and accept PAN-WAY® Snap-on Faceplates
- PAN-WAY® Snap-on Communication Faceplates are available in horizontal and vertical sloped outlet orientation
- PAN-WAY® Snap-on Electrical Faceplates are available in 106 duplex and rectangular styles

Surface mount outlet boxes are available for both power and communication applications. They are compatible with PANDUIT® LD, LDP, LD2P10 and T-45 Raceway Systems. PANDUIT® Snap-on Faceplates mount directly to Cove, TG-70, T-70, Twin-70, T-45 Raceway Systems, PAN-WAY® FAST-SNAP™ Boxes and PAN-POLE™ Aluminum Outlet Poles.

PANDUIT®

NON-METALLIC SURFACE RACEWAY



PAN-WAY® FAST-SNAP™ Surface Mount Outlet Boxes

- JB1FS and JB2FS assemble without the use of screws for faster installation
- JB1FS and JB2FS accept PAN-WAY® Snap-on Faceplates for superior aesthetics
- JB1FS and JB2FS are supplied with adhesive backing to speed installation

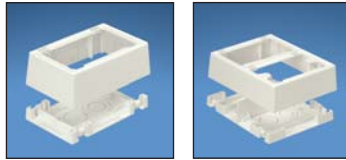

JB1FS

JBP2FS

Part Number	Part Description	Color‡	Std. Pkg. Qty.	Std. Ctn. Qty.
JB1FSIW-A	Single Gang Two-piece Snap Together Outlet Box with adhesive backing. Box accepts PAN-WAY® Snap-on Faceplates. For use with PAN-WAY® T-45 or LD Profile Raceway. 5.0"L x 3.3"W x 1.6"H (127.1mm x 82.7mm x 41.1mm). Breakouts for 1/2", 3/4", or 1" diameter conduit.	Off White	1	10
JBP2FSIW	Double Gang Two-piece Snap Together Outlet Box. Box accepts PAN-WAY® Snap-on Faceplates. For use with PAN-WAY® T-45 or LD Profile Raceway. 5.0"L x 6.1"W x 1.6"H (127mm x 156mm x 41mm). Breakouts for 1/2", 3/4", or 1" diameter conduit.	Off White	1	10

‡ For other colors replace IW (Off White) with EI (Electric Ivory), IG (International Gray) or WH (White).



PAN-WAY® Classic Series Snap-On Faceplates for Use with MINI-COM® Modules

- Can be used with PAN-WAY® Cove, TG-70, T-70, Twin-70, T-45 Raceway Systems, FAST-SNAP™ Outlet Boxes and PAN-POLE™ Aluminum Outlet Pole



T70FH2

T70FH4



T70FV2

T70FV4

Part Number	Part Description	Color‡	Std. Pkg. Qty.	Std. Ctn. Qty.
T70FH2IW	Snap-on Horizontal Sloped Communication Faceplate. Accepts two MINI-COM® modules (not included). No additional mounting hardware required.	Off White	1	10
T70FH4IW	Snap-on Horizontal Sloped Communication Faceplate. Accepts four MINI-COM® modules (not included). No additional mounting hardware required.	Off White	1	10
T70FV2IW	Snap-on Vertical Sloped Communication Faceplate. Accepts two MINI-COM® modules (not included). No additional mounting hardware required.	Off White	1	10
T70FV4IW	Snap-on Vertical Sloped Communication Faceplate. Accepts four MINI-COM® modules (not included). No additional mounting hardware required.	Off White	1	10

‡ For other colors replace IW (Off White) with EI (Electric Ivory), IG (International Gray) or WH (White).

Can be easily identified with labels, [reference chart on page J17](#).

Component Labels for Classic Series Snap-On Faceplates

Suggested Label Solutions for TIA/EIA-606-A Compliance			
Faceplate Part Number	Laser/Ink Jet Desktop Printer Label	VIPER™ LS6 Portable Printer Label	PANACEA® LS7 Hand-Held Printer Label
T70FH2IW T70FV2IW	C125X030FJJ	C125X030FJ6	LS7-25-1
T70FV4IW T70FH4IW	2-C125X030FJJ	2-C125X030FJ6	LS7-25-1
	C261X030FJJ	C261X030FJ6	LS7-25-1

For complete labeling solutions and product information, [reference chart on page J17](#).



PAN-WAY® Classic Series Snap-On Faceplates for Use with MINI-COM® Inserts

- Single gang vertical or horizontal sloped communication faceplates accept one or two *MINI-COM*® inserts
- Can be used with *PAN-WAY*® Cove, TG-70, T-70, Twin-70, T-45 Raceway Systems, *FAST-SNAP*™ Outlet Boxes and *PAN-POLE*™ Aluminum Outlet Pole



Part Number	Part Description	Color‡	Std. Pkg. Qty.	Std. Ctn. Qty.
T70BH1IW	Snap-on Horizontal Communication Faceplate. Accepts one 1/2-size <i>MINI-COM</i> ® Insert and two modules. No additional mounting hardware required.	Off White	1	10
T70BH2IW	Snap-on Horizontal Communication Faceplate. Accepts two 1/2-size <i>MINI-COM</i> ® Inserts and four modules. No additional mounting hardware required.	Off White	1	10
T70B1IW	Snap-on Vertical Communication Faceplate. Holds one 1/2-size <i>MINI-COM</i> ® Insert and two modules. No additional mounting hardware required.	Off White	1	10
T70B2IW	Snap-on Vertical Communication Faceplate. Holds two 1/2-size <i>MINI-COM</i> ® Inserts and four modules. No additional mounting hardware required.	Off White	1	10

‡ For other colors replace IW (Off White) with EI (Electric Ivory), IG (International Gray) or WH (White). Can be clearly identified with labels, [reference chart on page J17](#).



PAN-WAY® Classic Series Snap-On Faceplates for Communication/Power

- Can be used with *PAN-WAY*® Cove, TG-70, T-70, Twin-70, T-45 Raceway Systems, *FAST-SNAP*™ Outlet Boxes and *PAN-POLE*™ Aluminum Outlet Pole

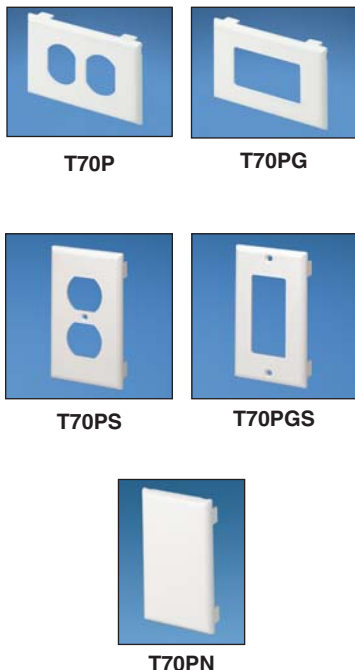

Part Number	Part Description	Color‡	Std. Pkg. Qty.	Std. Ctn. Qty.
T70PIW	Snap-on Single Gang 106 Duplex Electrical/Communication Faceplate. Used to cover one NEMA standard 106 duplex electrical outlet. In communication applications, covers one standard 106 duplex communication module frame. No additional mounting hardware required.	Off White	1	10
T70PGIW	Snap-on Single Gang Rectangular Electrical/Communication Faceplate. Used to cover one NEMA standard rectangular electrical outlet. In communication applications, covers one standard rectangular communication module frame. No additional mounting hardware required.	Off White	1	10
T70PSIW	Single Gang 106 Duplex Communication Faceplate. Used to cover one NEMA standard 106 duplex communication module frame. Module frame screw mounts directly to underside of snap-on faceplate. No mounting device needed. Supplied with one mounting screw. NOTE: Not for use with electrical devices.	Off White	1	10
T70PGSIW	Snap-on Single Gang Rectangular Communication Faceplate. Used to cover one NEMA standard rectangular communication module frame. Module frame screw mounts directly to underside of snap-on faceplate. No mounting device needed. Supplied with two mounting screws. NOTE: Not for use with electrical devices.	Off White	1	10
T70PNIW	Snap-on Single Gang Blank Cover Faceplate.	Off White	1	10

‡ For other colors replace IW (Off White) with EI (Electric Ivory), IG (International Gray) or WH (White). Can be clearly identified with labels, [reference chart on page J17](#).

PANDUIT®

NON-METALLIC SURFACE RACEWAY

NETKEY™ Snap-On Sloped Keystone Faceplates

- Accepts all NETKEY™ Keystone Copper Modules and Duplex Fiber Optic Modules

- Can be used with PAN-WAY® Cove, TG-70, T-70, Twin-70, T-45 Raceway Systems, FAST-SNAP™ Outlet Boxes and PAN-POLE™ Aluminum Outlet Pole

Part Number	Part Description	Color‡	Std. Pkg. Qty.	Std. Ctn. Qty.
NK2HSRFIW	Snap-on two position sloped horizontal faceplate accepts any NETKEY™ module. Compatible with PANDUIT® FAST-SNAP™ Outlet Boxes, Surface Raceway Systems and PAN-POLE™ Outlet Poles.	Off White	1	10
NK4HSRFIW	Snap-on four position sloped horizontal faceplate accepts any NETKEY™ module. Compatible with PANDUIT® FAST-SNAP™ Outlet Boxes, Surface Raceway Systems and PAN-POLE™ Outlet Poles.	Off White	1	10
NK4VSRFIW	Snap-on four position sloped vertical faceplate accepts any NETKEY™ module. Compatible with PANDUIT® FAST-SNAP™ Outlet Boxes, Surface Raceway Systems and PAN-POLE™ Outlet Poles.	Off White	1	10



NK2HSRF



NK4HSRF



NK4VSRF

‡ For other colors replace IW (Off White) with EI (Electric Ivory), IG (International Gray), or WH (White).
For complete labeling solutions and product information, [reference chart on page J17](#).

NETKEY™ Snap-On Flush Universal Keystone Faceplates

- Wider module spacing to accept all common manufacturers' Keystone modules .900 inches wide or less

- Can be used with PAN-WAY® Cove, TG-70, T70, Twin-70, T-45 Raceway Systems, FAST-SNAP™ Outlet Boxes and PAN-POLE™ Aluminum Outlet Poles

Part Number	Part Description	Color‡	Std. Pkg. Qty.	Std. Ctn. Qty.
T70KW2IW	Snap-on two position flush mount faceplate accepts any NETKEY™ module and most other manufacturers' Keystone modules. Compatible with PANDUIT® FAST-SNAP™ Outlet Boxes, Surface Raceway Systems and PAN-POLE™ Outlet Poles.	Off White	1	10
T70KW4IW	Snap-on four position flush mount faceplate accepts any NETKEY™ module and most other manufacturers' Keystone modules. Compatible with PANDUIT® FAST-SNAP™ Outlet Boxes, Surface Raceway Systems and PAN-POLE™ Outlet Poles.	Off White	1	10



T70KW2



T70KW4

‡ For other colors replace IW (Off White) with EI (Electric Ivory), IG (International Gray), or WH (White).
For complete labeling solutions and product information, [reference chart on page J17](#).

Component Labels for Snap-On "Sloped" (Keystone) Faceplates and Snap-On "Flush" Universal (Keystone) Faceplates

Suggested Label Solutions for TIA/EIA-606-A Compliance

Faceplate Part Number	Laser/Ink Jet Desktop Printer Label	VIPER™ LS6 Portable Printer Label	PANACEA® LS7 Hand-Held Printer Label
NK2HSRFIW T70KW2IW	C125X030FJJ	C125X030FJ6	LS7-25-1
NK4VSRFIW	2-C125X030FJJ	2-C125X030FJ6	LS7-25-1
NK4HSRFIW T70KW4IW	C261X030FJJ	C261X030FJ6	LS7-25-1

For complete labeling solutions and product information, [reference chart on page J17](#).



PAN-WAY® Snap-On Faceplates for Avaya®/CommScope® Communication Modules

- Can be used with PAN-WAY® Cove, TG-70, T70, Twin-70, T-45 Raceway Systems, FAST-SNAP™ Outlet Boxes and PAN-POLE™ Aluminum Outlet Poles



T70L2



T70L4



T70LV2



T70LV4

Part Number	Part Description	Color‡	Std. Pkg. Qty.	Std. Ctn. Qty.
T70L2IW	Snap-on Horizontal Communication Faceplate designed to accept two Avaya®/CommScope® Communication Modules (not included). Can be used with PANDUIT® Surface Raceway Systems and boxes that accept 70mm faceplates. No additional mounting hardware required.	Off White	1	10
T70L4IW	Snap-on Horizontal Communication Faceplate designed to accept four Avaya®/CommScope® Communication Modules (not included). Can be used with PANDUIT® Surface Raceway Systems and boxes that accept 70mm faceplates. No additional mounting hardware required.	Off White	1	10
T70LV2IW	Snap-on Vertical Communication Faceplate designed to accept two Avaya®/CommScope® Communication Modules (not included). Can be used with PANDUIT® Surface Raceway Systems and boxes that accept 70mm faceplates. No additional mounting hardware required.	Off White	1	10
T70LV4IW	Snap-on Vertical Communication Faceplate designed to accept four Avaya®/CommScope® Communication Modules (not included). Can be used with PANDUIT® Surface Raceway Systems and boxes that accept 70mm faceplates. No additional mounting hardware required.	Off White	1	10

‡ For other colors replace IW (Off White) with EI (Electric Ivory), IG (International Gray) or WH (White).
For complete labeling solutions and product information, [reference chart on page J17](#).

Component Labels for Avaya®/CommScope® Communication Modules

Faceplate Part Number	Suggested Label Solutions for TIA/EIA-606-A Compliance		
	Laser/Ink Jet Desktop Printer Label	VIPER™ LS6 Portable Printer Label	PANACEA® LS7 Hand-Held Printer Label
T70L2IW T70LV2IW	C125X030FJJ	C125X030FJ6	LS7-25-1
T70LV4IW	2-C125X030FJJ	2-C125X030FJ6	LS7-25-1
T70L4IW	C261X030FJJ	C261X030FJ6	LS7-25-1

For complete labeling solutions and product information, [reference chart on page J17](#).

^ Avaya is a registered trademark of Avaya, Inc.

* CommScope is a registered trademark of CommScope Properties, L.L.C.



PAN-WAY® Snap-On Faceplates for Nordx/CDT* Communication Modules

- Can be used with *PAN-WAY*® Cove, TG-70, T70, Twin-70, T-45 Raceway Systems, *FAST-SNAP*™ Outlet Boxes and *PAN-POLE*™ Aluminum Outlet Poles



T70N2



T70N4



T70NV2



T70NV4

Part Number	Part Description	Color‡	Std. Pkg. Qty.	Std. Ctn. Qty.
T70N2IW	Snap-on Horizontal Communication Faceplate designed to accept two Nordx/CDT® Communication Modules (not included). Can be used with <i>PANDUIT</i> ® Surface Raceway Systems and boxes that accept 70mm faceplates. No additional mounting hardware required.	Off White	1	10
T70N4IW	Snap-on Horizontal Communication Faceplate designed to accept four Nordx/CDT® Communication Modules (not included). Can be used with <i>PANDUIT</i> ® Surface Raceway Systems and boxes that accept 70mm faceplates. No additional mounting hardware required.	Off White	1	10
T70NV2IW	Snap-on Vertical Communication Faceplate designed to accept two Nordx/CDT® Communication Modules (not included). Can be used with <i>PANDUIT</i> ® Surface Raceway Systems and boxes that accept 70mm faceplates. No additional mounting hardware required.	Off White	1	10
T70NV4IW	Snap-on Vertical Communication Faceplate designed to accept four Nordx/CDT® Communication Modules (not included). Can be used with <i>PANDUIT</i> ® Surface Raceway Systems and boxes that accept 70mm faceplates. No additional mounting hardware required.	Off White	1	10

‡ For other colors replace IW (Off White) with EI (Electric Ivory).

For complete labeling solutions and product information, [reference chart on page J17](#).

Component Labels for Nordx/CDT® Communication Modules

Suggested Label Solutions for TIA/EIA-606-A Compliance

Faceplate Part Number	Laser/Ink Jet Desktop Printer Label	VIPER™ LS6 Portable Printer Label	PANACEA® LS7 Hand-Held Printer Label
T70N2IW T70NV2IW	C125X030FJJ	C125X030FJ6	LS7-25-1
T70NV4IW	2-C125X030FJJ	2-C125X030FJ6	LS7-25-1
T70N4IW	C261X030FJJ	C261X030FJ6	LS7-25-1

For complete labeling solutions and product information, [reference chart on page J17](#).

* Nordx/CDT is a registered trademark of Nordx/CDT, Inc.



PAN-WAY® Low Voltage Surface Mount Outlet Boxes

- JBX3510 assembles without the use of screws for faster installation
- JBX3510, JB1, and JB1D are supplied with adhesive backing to speed installation
- JB1 and JB1D are a one-piece design requiring no assembly



JBX3510



JB1

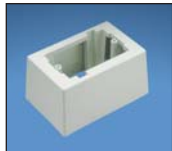

JB1D



JBP2



JBP2D









JBA-X

Part Number	Part Description	Color‡	Std. Pkg. Qty.	Std. Ctn. Qty.
JBX3510IW-A	Single Gang Two-piece Snap Together Outlet Box with adhesive backing. Box accepts <i>PAN-WAY</i> ® Screw-on Faceplates or any NEMA standard single gang faceplate. For use with <i>PAN-WAY</i> ® T45 or LD Profile Raceway. 5.0"L x 3.3"W x 1.6"H (127mm x 83mm x 41mm). Breakouts for 1/2", 3/4", or 1" diameter conduit.	Off White	1	10
JB1IW-A	Single Gang One-piece Outlet Box with adhesive backing. Box accepts <i>PAN-WAY</i> ® Screw-on Faceplates or any NEMA standard single gang faceplate. For use with <i>PAN-WAY</i> ® LD Profile Raceway. 5.1"L x 3.3"W x 1.8"H (129mm x 85mm x 44mm). Breakouts for 1/2", 3/4", or 1" diameter conduit.	Off White	1	10
JB1DIW-A	Single Gang One-piece Deep Outlet Box with adhesive backing. Box accepts <i>PAN-WAY</i> ® Screw-on Faceplates or any NEMA standard single gang faceplate. For use with <i>PAN-WAY</i> ® T-45 or LD Profile Raceway. 5.2"L x 3.5"W x 2.8"H (133mm x 86mm x 70mm). Breakouts for 1/2", 3/4", or 1" diameter conduit.	Off White	1	10
JBP2IW	Double Gang Two-piece Screw Together Outlet Box. Box accepts <i>PAN-WAY</i> ® Screw-on Faceplates or any NEMA standard double gang faceplates. For use with <i>PAN-WAY</i> ® LD Profile Raceway. 5.0" L x 5.0"W x 1.6"L (128mm x 128mm x 41mm). Breakouts for 1/2" or 3/4" diameter conduit.	Off White	1	10
JBP2DIW	Double Gang Two-piece Screw Together Deep Outlet Box. Box accepts <i>PAN-WAY</i> ® Screw-on Faceplates or any NEMA standard double gang faceplate. For use with <i>PAN-WAY</i> ® T-45 or LD Profile Raceway. 5.2"L x 5.2"W x 2.8"H (132mm x 132mm x 70mm). Breakouts for 1/2", 3/4", or 1" diameter conduit.	Off White	1	10
JBA-X	In-wall box adapter. Adapts single gang surface mount outlet boxes to in-wall conduit boxes.	—	10	100

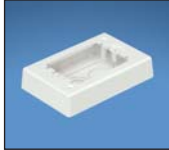
‡ For other colors replace IW (Off White) with EI (Electric Ivory), IG (International Gray) or WH (White).

PANDUIT[®]**NON-METALLIC SURFACE RACEWAY****PAN-WAY[®] Power Rated Surface Mount Outlet Boxes**

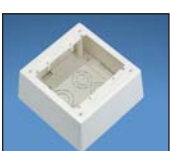
- JBX3510 assembles without the use of screws for faster installation
- JBX3510, JB1 and JB1D are supplied with adhesive backing to speed installation
- JB1 and JB1D are a one-piece design requiring no assembly

Part Number	Part Description	Color‡	Std. Pkg. Qty.	Std. Ctn. Qty.
 JBP1				
 JBP1I				
 JBP2				
 JBP2D				
 JBD2				
JBP1IW	Single Gang Two-piece Screw Together Outlet Box. Box accepts <i>PAN-WAY</i> [®] Screw-on Faceplates or any NEMA standard single gang faceplate. For use with <i>PAN-WAY</i> [®] LD Profile Raceways. 5.2"L x 3.5"W x 1.8"H (132mm x 88mm x 44mm). Breakouts for 1/2", 3/4", or 1" diameter conduit.	Off White	1	10
JBP1EIW	Single Gang Two-piece Screw Together Extension Outlet Box. Box accepts <i>PAN-WAY</i> [®] Screw-on Faceplates or any NEMA standard single gang faceplate. For use with <i>PAN-WAY</i> [®] LD Profile Raceway. 5.0"L x 3.3"W x 1.0"H (127mm x 84mm x 25mm). Breakouts for 1/2", 3/4", or 1" diameter conduit.	Off White	1	10
JBP1IIW	Single Gang Two-piece Screw Together Intermediate Outlet Box. Box accepts <i>PAN-WAY</i> [®] Screw-on Faceplates or any NEMA standard single gang faceplate. For use with <i>PAN-WAY</i> [®] LD Profile Raceway. 5.1"L x 3.4"W x 2.3"H (130mm x 86mm x 58mm). Breakouts for 1/2" or 3/4" diameter conduit.	Off White	1	10
JBP1DIW	Single Gang Two-piece Screw Together Deep Outlet Box. Box accepts <i>PAN-WAY</i> [®] Screw-on Faceplates or any NEMA standard single gang faceplate. For use with <i>PAN-WAY</i> [®] T-45, LD2P10 (when used with JBD1), or LD Profile Raceways. 5.2"L x 3.5"W x 2.8"H (132mm x 88mm x 70mm). Breakouts for 1/2", 3/4", or 1" diameter conduit.	Off White	1	10
JBP2IW	Double Gang Two-piece Screw Together Outlet Box. Box accepts <i>PAN-WAY</i> [®] Screw-on Faceplates or any NEMA standard double gang faceplates. For use with <i>PAN-WAY</i> [®] LD Profile Raceway. 5.0" L x 5.0"W x 1.6"L (128mm x 128mm x 41mm). Breakouts for 1/2" or 3/4" diameter conduit.	Off White	1	10
JBP2SIW	Double Gang Two-piece Screw Together Divided Outlet Box. Box accepts <i>PAN-WAY</i> [®] Screw-on Faceplates or any NEMA standard double gang faceplate. For use with <i>PAN-WAY</i> [®] T-45 or LD Profile Raceway. 5.1"L x 5.1"W x 1.6"H (128mm x 128mm x 41mm). Breakouts for 1/2", or 3/4" diameter conduit.	Off White	1	10
JBP2DIW	Double Gang Two-piece Screw Together Deep Outlet Box. Box accepts <i>PAN-WAY</i> [®] Screw-on Faceplates or any NEMA standard double gang faceplate. For use with <i>PAN-WAY</i> [®] T-45 or LD Profile Raceway. 5.2"L x 5.2"W x 2.8"H (132mm x 132mm x 70mm). Breakouts for 1/2", 3/4", or 1" diameter conduit.	Off White	1	10
JBD1	Single Gang Pass Through Divider. Allows power and communication outlets to be routed in series. For use with JBP1 or JBP1D when installing LD2P10 Raceway.	Off White	1	10
JBD2	Double Gang Pass Through Divider. Allows power and communication outlets to be routed in series. For use with JBP2D when installing LD2P10 Raceway.	Off White	1	10

‡ For other colors replace IW (Off White) with EI (Electric Ivory), IG (International Gray) or WH (White).



PAN-WAY® Power Rated Surface Mount Outlet Boxes (Continued)



RJBX3510

PSJBX



JBP1MR20

JBP1MD20

Part Number	Part Description	Color	Std. Pkg. Qty.	Std. Ctn. Qty.
RJBX3510IW	Single Gang Two-piece Screw Together Round Outlet Box. Box accepts UL/CSA devices not to exceed 10lbs. (5lbs. per CSA). For use with PAN-WAY® LD Profile Raceway. Dia. = 5.5"D x 1.1"H (139mm x 29mm). Breakouts for 3/4" or 1" diameter conduit.	Off White	1	5
PSJBXIW	Single Gang Two-piece Snap Together Power Source Box. For use with PAN-WAY® LDP3, 5, 10, or LDS3, or 5 Profile Raceway. 5.0"L x 3.3"W x 1.3"H (128mm x 83mm x 33mm). Breakouts for 1/2", 3/4", or 1" diameter conduit.	Off White	1	10
JBP1MR20IW	Single Gang Two-piece Power Rated Low Profile Snap Together Outlet Box. Includes 20A U.S. style 106 duplex electrical outlet. For use with PAN-WAY® LDP3, 5, 10 or LDS3 or 5 Profile Raceway only. 4.8"L x 2.9"W x 1.2"H (123mm x 74mm x 31mm).	Off White	1	10
JBP1MD20IW	Single Gang Two-piece Power Rated Low Profile Snap Together Outlet Box. Includes 20A U.S. style rectangular electrical outlet. For use with PAN-WAY® LDP3, 5, 10 or LDS3 or 5 Profile Raceway only. 4.8"L x 2.9"W x 1.2"H (123mm x 74mm x 31mm).	Off White	1	10

‡ For other colors replace IW (Off White) with EI (Electric Ivory), IG (International Gray) or WH (White).

System Overview

Quick Selection Guide

Office Furniture

Cove

TG-70

T-70 & Twin-70

T-45

Ultimate ID System

Faceplates, Boxes & Labeling

LD Profile

T130









Outlet Pole

Technical Info

Glossary & Index



PAN-WAY® Classic Series Faceplates for Power and Communication Applications

Part Number	Part Description	Color‡	Std. Pkg. Qty.	Std. Ctn. Qty.
 FP2DC	FP2DCIW Covers one NEMA standard 106 duplex electrical receptacle and accepts <i>MINI-COM</i> ® 1/2-size, 1/3-size, and 2/3-size inserts. Supplied with screws. For product application, please reference LD Profile Raceway section.	Off White	1	10
 FP2RC				
 CP106	CP106IW Screw-on Single Gang Rectangular Faceplate. Covers one NEMA standard 106 duplex electrical outlet or one standard 106 communication module frame. Supplied with one mounting screw.	Off White	1	10
 CP106**2G				
 CPG	CPGIW Screw-on Single Gang Rectangular Faceplate. Covers one NEMA standard rectangular electrical outlet or one standard rectangular communication module frame. Supplied with two mounting screws.	Off White	1	10
 CPGIW**2G				
 CPN	CPNIW Screw-on Single Gang Blank Cover Faceplate. Can be used with <i>PAN-WAY</i> ® Cove, TG-70, T-70, Twin-70, T-45 Raceway Systems, <i>FAST-SNAP</i> ™ Outlet Boxes, and <i>PAN-POLE</i> ™ Aluminum Outlet Pole. Supplied with two mounting screws.	Off White	1	10
 CPNIW**2G				
	CPNIW-2G Screw-on Double Gang Blank Cover Faceplate. For use with <i>PAN-WAY</i> ® Surface Mount Outlet Boxes. Supplied with four mounting screws.	Off White	1	10

‡ For other colors, replace IW (Off White) with EI (Electric Ivory), IG (International Gray) or WH (White).
For complete labeling solutions and product information, [reference chart on page J17](#).

Component Labels for Classic Series Power and Communication Faceplates

Suggested Label Solutions for TIA/EIA-606-A Compliance

Faceplate Part Number	Laser/Ink Jet Desktop Printer Label	VIPER™ LS6 Portable Printer Label	PANACEA® LS7 Hand-Held Printer Label
CPGIW T70PGS	C125X030FJJ	C125X030FJ6	LS7-25-1
CPGIW-2G FP2RC	2-C125X030FJJ	2-C125X030FJ6	LS7-25-1
T70PG	C261X030FJJ	C261X030FJ6	LS7-25-1

For complete labeling solutions and product information, [reference chart on page J17](#).

UL LISTED SP PAN-WAY® Stainless Steel Faceplates



WPS-20



WPS-202

Part Number	Part Description	Std. Pkg. Qty.	Std. Ctn. Qty.
WPS-20	Stainless Steel Single Gang Rectangular Screw-on Faceplate. Covers one NEMA standard 106 duplex electrical outlet or one standard 106 communication module frame. Supplied with one mounting screw.	1	10
WPS-202	Stainless Steel Double Gang Rectangular Screw-on Faceplate. Covers two NEMA standard 106 duplex electrical outlets or two standard 106 communication module frames. Supplied with two mounting screws.	1	10

UL SA LISTED SP PAN-WAY® Electrical Outlets

• Electrical outlets are standard electrical devices that fit into PAN-WAY® outlet boxes or any NEMA standard outlet boxes



EDU20



ERU20



ETU20



EGU20

Part Number	Part Description	Color‡	Std. Pkg. Qty.	Std. Ctn. Qty.
EDU20IW-X	20A 106 Duplex Outlet. Supplied with two mounting screws.	Off White	10	100
ERU20IW-X	20A Rectangular Outlet. Supplied with two mounting screws.	Off White	10	100
ETU20IW-X	20A TVSS Rectangular Outlet (transient voltage surge suppressor). Supplied with two mounting screws.	Off White	10	100
EGU20IW-X	20A GFCI Rectangular Outlet (ground fault circuit interrupter). Supplied with two mounting screws.	Off White	10	100

‡ For other colors, replace IW (Off White) with EI (Electric Ivory).

Raceway Adapters for LD Raceway

- Fits into universal breakout of DCEFX and RAEFX fittings
- For use with LDP3, LD3, and LDS3 raceway and LDP5, LD5 and LDS5 raceway



CA3
CA5

Part Number	Part Description	Color‡	Std. Pkg. Qty.	Std. Ctn. Qty.
CA3IW-X	Fits into universal breakout of DCEFX or RAEFX fittings. For use LD3, LDP3, and LDS3 raceway.	Off White	10	50
CA5IW-X	Fits into universal breakout of DCEFX or RAEFX fittings. For use LD5, LDP5, and LDS5 raceway.	Off White	10	50

‡ For other colors replace IW (Off White) with EI (Electric Ivory), IG (International Gray), or WH (White).

Selection Chart for using *PAN-WAY*® Surface Raceway with *PAN-WAY*® Surface Mount Outlet Boxes

How to use this chart:

1. Locate the desired *PAN-WAY*® Raceway in the left column.
2. Locate the desired *PAN-WAY*® Outlet Box in the top row.
3. Match up the raceway with the outlet box to see if they are compatible. (Y = Yes, N = No).
4. Select correct surface mount outlet box.

PAN-WAY® Surface Mount Outlet Boxes

	Low Voltage or Fiber Optic ONLY	Power, Low Voltage or Fiber Optic							
	JB1, JB1D JB1FS JBX3510	RJBX3510	JBP1	JBP1D	JBP1E	JBP11 JBP2	JBP2S JBP2D JBP2FS	JBP1MR20 JBP1MD20	PSJBX
Type LD (Low Voltage or Fiber Optic ONLY)									
LD3	Y	Y	Y	Y	Y	Y	Y	N	Y
LD5	Y	Y	Y	Y	Y	Y	Y	N	Y
LD10	Y	Y	Y	Y	Y	Y	Y	N	Y
Type LDP (Power, Low Voltage or Fiber Optic)									
LDP3	Y	Y	Y	Y	Y	Y	Y	Y	Y
LDP5	Y	Y	Y	Y	Y	Y	Y	Y	Y
LDP10	Y	Y	Y	Y	Y	Y	Y	Y	Y
Type LDS (Power, Low Voltage or Fiber Optic)									
LDS3	Y	Y	Y	Y	Y	Y	Y	Y	Y
LDS5	Y	Y	Y	Y	Y	Y	Y	Y	Y
Type LD2P10 (Power, Low Voltage or Fiber Optic)									
LD2P10	N	N	N	Y w/JBD1	N	N	Y	N	N
Type T-45 (Power, Low Voltage or Fiber Optic)									
T-45	Y (JB1FS and JBX3510)	N	N	Y	N	N	Y	N	N

LABELING & ADMINISTRATION

A world leader in identification solutions, *PANDUIT®* designs and manufactures labeling products, software and printers to assist with TIA/EIA-606-A compliance.



The TIA/EIA-606-A standard states:

- Size, color and contrast of all labels should be selected to ensure that the identifiers are easily read
- Labels should be visible during the installation of and normal maintenance of the infrastructure
- Labels should be resistant to the environmental conditions at the point of installation (such as moisture or heat) and should have a design life equal to or greater than that of the labeled component
- To maximize legibility, all labels shall be printed or generated by a mechanical device

PANDUIT® Identification Solutions include a full line of TIA/EIA-606-A standard compliant labeling products. Properly identifying your network allows moves, adds, changes, trouble shooting and repairs to be accomplished faster and more efficiently.

PANDUIT[®]**NON-METALLIC SURFACE RACEWAY****PANA^{CEA}® LS7 Hand-Held Thermal Transfer Printer and Accessories**

- Multipurpose printer supports *ULTIMATE ID*[™] System and additional network labeling requirements; for detailed printing instructions to create *ULTIMATE ID*[™] labels using the *PANA^{CEA}*® LS7 printer, request **SA-IDSP01**
- High quality thermal transfer print for professional looking labels that will not smear
- Fast loading label cassette includes both label material and ribbon to make changing labels easy
- No more spacing and guess work — length function aligns legends with ports
- Advanced functions including serialization, vertical and horizontal lines, symbol library and memory
- Six AA alkaline batteries and hardside case included

**LS7**

Part Number	Part Description	Std. Pkg. Qty.	Std. Ctn. Qty.
LS7	Printer Kit (includes printer, 3/4" (18mm) non-laminated black/white cassette, hardside carrying case, wrist strap, 6 AA alkaline batteries, label separator tool and operator's manual).	1	4
LS7-ACS	120 VAC adapter*	1	6
LS7-CLN	Cleaning cassette	1	20

*Cannot be used to charge batteries.

For a full product offering of the *PANA^{CEA}*® LS7 Hand-Held Printer, request product bulletin **SA-IDCB1000A**.**VIPER[™] LS6 Portable Thermal Transfer Printer and Accessories**

- Create wiremarkers, heat shrink labels, continuous tapes, component labels, bin markers, pipe markers, safety/facility identification and network connectivity labels
- High quality thermal transfer print for professional looking labels that will not smear
- AC adapter included so you can start printing right out of the box
- Serial port/PC interfacing
- Fast loading ribbon cartridge lets you slide, lock and go!
- 128K file memory reduces setup time by recalling frequently used labels
- Nickel metal hydride battery provides longer battery life
- Advanced functions including serialization, bar code printing, vertical and horizontal lines, date and time stamp, variety of font sizes and a symbol library containing over 35 electrical, safety and network symbols

**LS6-KIT**

Part Number	Part Description	Std. Pkg. Qty.	Std. Ctn. Qty.
LS6-KIT	LS6 printer, LS6-RWBLK ribbon, battery pack, 120V AC adapter/charger, hardside case and English operator's manual.	1	—
LS6-RWBLK	LS6 wax ribbon, black, 2" x 100'. For use with self-laminating vinyl, heat shrink and vinyl cloth materials.	1	6
LS6-RRBLK	LS6 resin ribbon, black, 2" x 100'. For use with polyester, polyolefin and vinyl materials.	1	6
LS6-RHBLK	LS6 hybrid ribbon, black, 2" x 100'. For use with self-laminating vinyl, heat shrink and vinyl cloth materials.	1	6
LS6-RRWHT	LS6 resin ribbon, white, 2" x 75'. For use with clear and colored polyester and vinyl tapes.	1	6
LS6-BP	LS6 replacement battery pack.	1	6
LS6-ACS	LS6 replacement 120V AC adapter/charger.	1	—
LS6-PCKIT	LS6 PC interface kit includes serial cable and <i>VIPERLINK</i> [™] Software.	1	—
LS6-CLN	LS6 cleaning kit, package of 5 printer cleaning cards.	1	5

For a full product offering of the *VIPER*[™] LS6 Portable Printer, request product bulletin **SA-ID07BR01B**.

PAN-MARK® for WINDOWS^ Labeling Software

- PAN-MARK® for WINDOWS^ Labeling Software has preloaded and ready to use; thermal transfer, dot-matrix, laser and ink jet label formats, including *ULTIMATE ID™* System formats
- ODBC (Open Data-Base Connectivity) allows importing of information from electronic databases such as EXCEL^ and ACCESS^ directly onto the label formats
- On-line help function files, including the TIA/EIA-606-A Labeling Compliance Brochure that assists in understanding the TIA/EIA-606-A standard and insure network labeling compliance
- Easy to install and supplied on CD-ROM

- Uses full range of WINDOWS^ fonts including True Type* fonts
- Use image library to add commonly used symbols to your labels (fax, data, voice, etc.)
- Import bitmap (.bmp) graphic images into a label
- Create alpha and numeric serializations

System Requirements:

- WINDOWS^ 95, 98, Me, 2000, NT 4.x, and XP; minimum 486 processor; minimum 8MB of RAM; 30 MB hard drive space



Part Number	Part Description	Std. Pkg. Qty.	Std. Ctn. Qty.
PROG-WIN2CD	WINDOWS^ labeling software, CD-ROM, Compatible with WINDOWS^ 95, 98, Me, 2000, NT 4.x and XP	1	10

For detailed information on PAN-MARK® for WINDOWS^ Labeling Software, request product bulletin SA-IDCB1043A.

^ WINDOWS, EXCEL and ACCESS are registered trademarks of Microsoft Corp.

*True Type is a registered trademark of Apple Computing, Inc.

EASY-MARK™ Labeling Software

- WYSIWYG — **What You See Is What You Get** — program allows you to see labels on-screen as they will appear when printed
- Quick text entry — feature allows you to enter text on individual labels or over an entire range
- Advanced alpha and numeric serialization speeds label creation
- All PANDUIT® thermal transfer, dot-matrix, laser and inkjet label formats, including *ULTIMATE ID™* System are preloaded and ready to use
- On-line help function files, including the TIA/EIA-606-A Labeling Compliance Brochure that assists in understanding the TIA/EIA-606-A standard and insure network labeling compliance

- Easy to install and supplied on CD-ROM
- Uses full range of WINDOWS^ fonts including True Type* fonts

System Requirements:

- WINDOWS 95, 98, Me, 2000, NT4.x, and XP; minimum 486 processor; minimum 32 MB RAM; 64 MB hard drive space



Part Number	Part Description	Std. Pkg. Qty.	Std. Ctn. Qty.
PROG-EMCD	WINDOWS^ labeling software, CD-ROM, Compatible with WINDOWS^ 95, 98, Me, 2000, NT 4.x and XP	1	10

For detailed information on EASY-MARK™ Labeling Software, request product bulletin SA-IDCB02.

^ WINDOWS, EXCEL and ACCESS are registered trademarks of Microsoft Corp.

*True Type is a registered trademark of Apple Computing, Inc.

ULTIMATE ID™ Labeling Software for WINDOWS^

- Fast and easy creation of labels for *ULTIMATE ID™* Network Labeling System patch panels, faceplates, surface mount boxes, and marker ties
- Create alpha and numeric serializations
- ODBC (Open Data-Base Connectivity) allows importing of information from electronic databases such as EXCEL^ and ACCESS^ directly onto the label formats
- *ULTIMATE ID™* System formats are preloaded and ready to use
- On-line help function files, including the TIA/EIA-606-A Labeling Compliance Brochure that assists in understanding the TIA/EIA-606-A standard and insure network labeling compliance
- Easy to install and supplied on CD-ROM
- Image library that includes commonly used symbols for fax, data and voice
- Automatically aligns legends with ports on patch panels and faceplates
- Vertical line function enables users to separate legends
- Automatic font sizing
- Supports most WINDOWS^ printer drivers and is compatible with standard desktop laser and ink jet printers

System Requirements:

- WINDOWS^ 95, 98, Me, 2000, NT 4.x, and XP; minimum 486 processor; minimum 10MB of RAM; 30 MB hard drive space

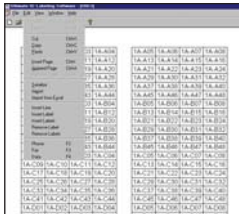

Part Number	Part Description	Std. Pkg. Qty.	Std. Ctn. Qty.
UISW	WINDOWS^ labeling software, CD-ROM, Compatible with WINDOWS^ 95, 98, Me, 2000, NT 4.x and XP.	1	10

^ WINDOWS, EXCEL and ACCESS are registered trademarks of Microsoft Corp.

ID GENERATOR™ Software



- *PANDUIT® ID GENERATOR™* Software lets users quickly and easily create TIA/EIA-606-A compliant horizontal link identifiers and upload them into various printers, label printing software and testing equipment
- Allows you to identify, record and label all horizontal links in your cabling infrastructure per the TIA/EIA-606-A requirements
- Uses an interview process to quickly determine your infrastructure layout
- Generates identifiers based on the interview information
- Prepares the identifiers for uploading into printers, testers and software for labeling and record keeping

After Horizontal Link Identifiers are generated, you can:

- Export information to EXCEL^ to generate reports and use with *PANDUIT® PAN-MARK®* for WINDOWS^ Labeling Software, *ULTIMATE ID™* Labeling Software and your desktop printer to generate labels
- Export to .dat file and use with the *PANDUIT® VIPER™* LS6 Portable Thermal Transfer Printer and *VIPERLINK™* Software to generate labels
- Export to .txt file and use with Fluke Networks* CableManager* Software or other .txt compliant software
- Export to .ids file and use with Fluke Networks DSP-4300 Digital Cable Analyzer for testing

PANDUIT® ID GENERATOR Software is available as a **FREE** download at <http://www.panduit.com/idgenerator.asp>

^ WINDOWS, EXCEL and ACCESS are registered trademarks of Microsoft Corp.
* Fluke Networks and Cable Manager are trademarks of Fluke Networks, Inc.

Component Labels for Laser/Ink Jet Desktop Printers Supplied on 8.5" x 11" Sheets

Part Number	Part Description	Width		Height		Std. Pkg. Qty.*	Std. Ctn. Qty.
		In.	mm	In.	mm		
C061X030FJJ	One port, white adhesive polyolefin labels.	.61	15.49	.30	7.62	5200	31200
C125X030FJJ	Two port, white adhesive polyolefin labels.	1.25	31.75	.30	7.62	2550	15300
C138X019FJJ	Module, white adhesive polyolefin labels.	1.38	35.05	.19	4.83	2550	15300
C188X030FJJ	Three port, white adhesive polyolefin labels.	1.88	47.75	.30	7.62	1000	6000
C195X040Y1J	Single gang, white non-adhesive polyester labels.	1.95	49.53	.40	10.16	1020	6120
C252X030FJJ	Four port, white adhesive polyolefin labels.	2.52	64.01	.30	7.62	1050	6300
C261X030FJJ	Four port, white adhesive polyolefin labels.	2.61	66.29	.30	7.62	1050	6300
C261X035Y1J	Four port, white non-adhesive polyester labels.	2.61	66.29	.35	8.89	1050	6300
C282X030Y1J	Four port, white non-adhesive polyester labels.	2.82	71.63	.30	7.62	1040	6240
C288X040Y1J	Double gang, white non-adhesive polyester labels.	2.88	73.15	.40	10.16	1000	6000
C379X030FJJ	Six port, white adhesive polyolefin labels.	3.79	96.27	.30	7.62	1000	6000
C390X030Y1J	Six port, white non-adhesive polyester labels.	3.90	99.06	.30	7.62	1040	6240

*Order number of labels required in multiples of Std. Pkg. Qty.

Component Labels for VIPER™ LS6 Portable Thermal Transfer Printer Supplied on Rolls

Part Number	Part Description	Width		Height		Std. Pkg. Qty.*	Std. Ctn. Qty.
		In.	mm	In.	mm		
C061X030FJ6	One port, white adhesive polyolefin label, 500/roll.	.61	15.49	.30	7.62	1	10
C125X030FJ6	Two port, white adhesive polyolefin label, 500/roll.	1.25	31.75	.30	7.62	1	10
C138X019FJ6	Module, white adhesive polyolefin label, 500/roll.	1.38	35.05	.19	4.83	1	10
C188X030FJ6	Three port, white adhesive polyolefin label, 500/roll.	1.88	47.75	.30	7.62	1	10
C195X040Y16	Single gang, white non-adhesive polyester label, 500/roll.	1.95	49.53	.40	10.16	1	10
C252X030VA6	Four port, white adhesive polyolefin label, 150/roll.	2.52	64.01	.30	7.62	1	10
C261X030FJ6	Four port, white adhesive polyolefin labels, 150/roll.	2.61	66.29	.30	7.62	1	10
C261X035Y16	Four port, white non-adhesive polyester label, 150/roll.	2.61	66.29	.35	8.89	1	10
C282X030Y16	Four port, white non-adhesive polyester label, 150/roll.	2.82	71.63	.30	7.62	1	10
C288X040Y16	Double gang, white non-adhesive polyester label, 150/roll.	2.88	73.15	.40	10.16	1	10
C379X030FA6	Six port, white adhesive polyolefin label, 150/roll.	3.79	96.27	.30	7.62	1	10
C390X030Y16	Six port, white non-adhesive polyester label, 150/roll.	3.90	99.06	.30	7.62	1	10

*Order number of rolls required.

For detailed information on VIPER™ LS6 Portable Thermal Transfer Printer, request product bulletin SA-ID07BR01B.

Component Cassettes for PANACEA® LS7 Hand-Held Thermal Transfer Printer

Part Number	Part Description	Height		Length		Std. Pkg. Qty.*	Std. Ctn. Qty.
		In.	mm	ft.	M		
LS7-25-1	Black/white laminated polyester label cassette.	.236	6.0	26.2	8.0	1	20
LS7-38-1	Black/white laminated polyester label cassette.	.354	9.0	26.2	8.0	1	20
LS7-50-1	Black/white laminated polyester label cassette.	.472	12.0	26.2	8.0	1	20
LS7-75NL-1	Black/white non-laminated polyester continuous label cassette.	.708	18.0	26.2	8.0	1	20

*Order number of cassettes required.

For a non-adhesive labeling solution, do not remove liner from label.

For detailed information on PANACEA® LS7 Hand-held Thermal Transfer Printer, request product bulletin SA-IDCB100A.

System
Overview

PANDUIT[®]

NON-METALLIC SURFACE RACEWAY

Quick
Selection
Guide

NOTES

Office
Furniture

Cove

TG-70

T-70
&
Twin-70

T-45

Ultimate
ID
System

Faceplates,
Boxes &
Labeling

LD Profile

T130

Outlet
Pole

Technical
Info

Glossary
&
Index

PAN-WAY® LD PROFILE NON-METALLIC SURFACE RACEWAY

PAN-WAY® LD Profile Raceway is available in single and multi-channel styles providing solutions for routing low voltage, fiber optic and power cabling along fixed perimeter walls. LD Profile Raceway is available with standard, bend radius control or power rated fittings.

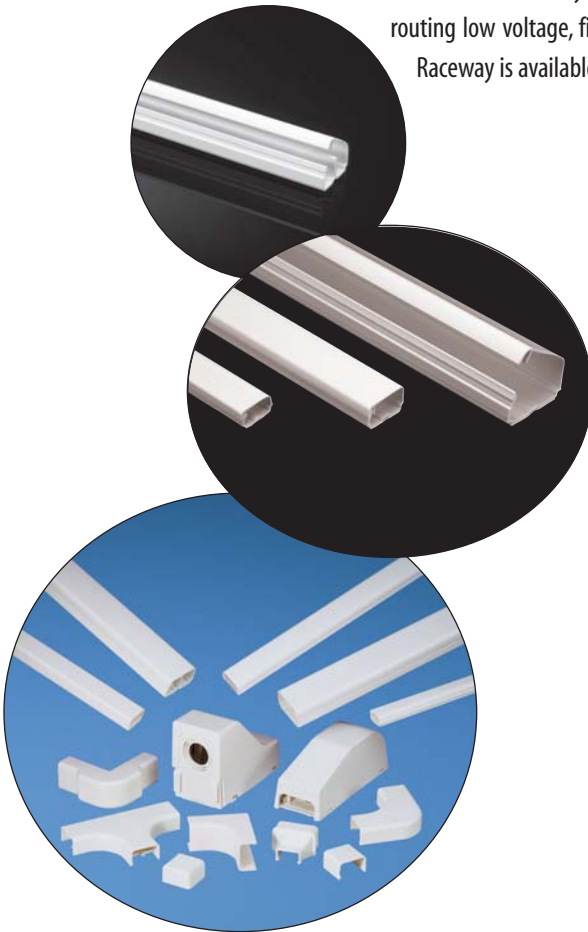

- LD2P10 features one-piece multi-channel design for both power and data applications
- LDP features one-piece single channel design with a tamper resistant latch for power OR data applications
- LD features one-piece single channel design for routing data and low voltage cabling
- LDS features one-piece single channel tamper resistant design for maximum security in power OR data applications
- Full complement of fittings to support all common power and data applications

LD2P10 Profile Raceway Roadmap

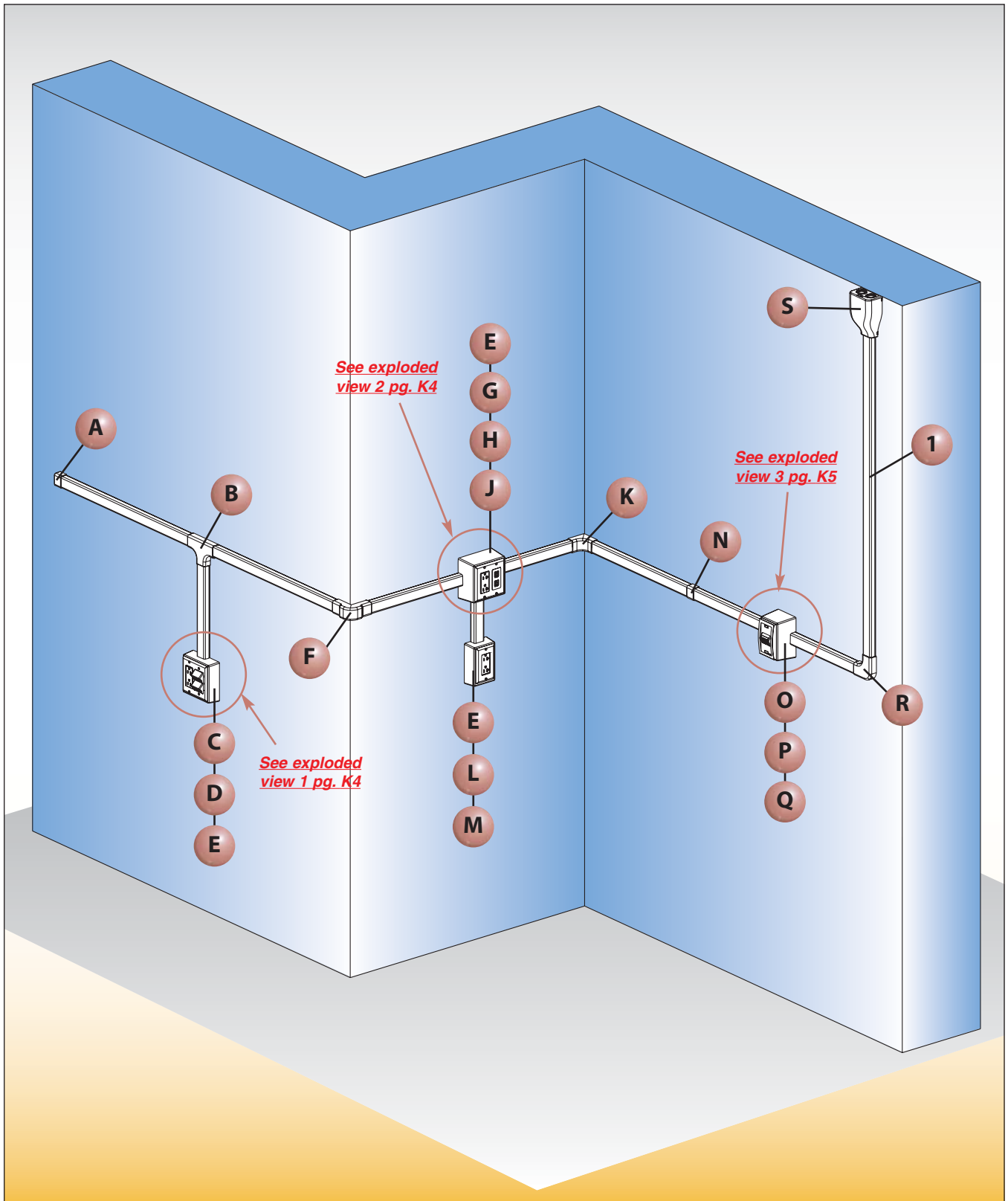

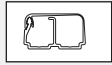

1 [LD2P10 Raceway \(page K13\)](#)



A [ECFX10** — Power Rated End Cap Fitting \(page K13\)](#)

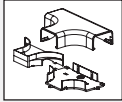

B [TFXD10** — 1" Bend Radius Tee Fitting \(page K13\)](#)

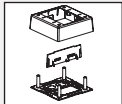

C [JBP2S** — Power Rated Double Gang Three-Piece Divided Box \(page J8\)](#)

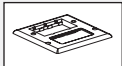

D [FP2RC** — Double Gang Rectangular Electrical and Two Communication Insert Faceplate \(page J10\)](#)

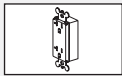

E [ERU20** — 20A Rectangular Electrical Outlet \(page J11\)](#)

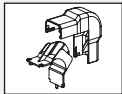

F [OCFX10** — 1" Bend Radius Outside Corner Fitting \(page K13\)](#)

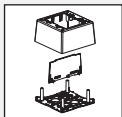

G [JBP2D** — Power Rated Double Gang Two-Piece Deep Box \(page J8\)](#)

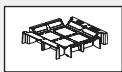

H [JBD2 — Double Gang Pass Through and Divider for LD2P10 Raceway \(page J8\)](#)

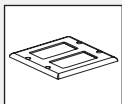

J [CPG**-2G — Double Gang Rectangular Screw-On Faceplate \(page J10\)](#)

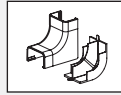

K [ICFX10** — Power Rated Inside Corner Fitting \(page K13\)](#)

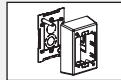

L [JBP1** — Power Rated Single Gang Two-Piece Box \(page J8\)](#)

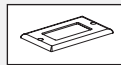

M [CPG** — Single Gang Rectangular Screw-On Faceplate \(page J10\)](#)

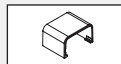

N [CFX10** — Power Rated Coupler Fitting \(page K13\)](#)

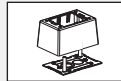

O [JBP1D** — Single Gang Two-Piece Deep Box \(page J8\)](#)



P [JBD1 — Single Gang Pass Through Divider for LD2P10 Raceway \(page J8\)](#)

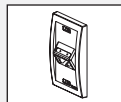

Q [UICFPSE2** — ULTIMATE ID™ Two-Position Executive Sloped Faceplate \(page H3\)](#)

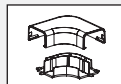

R [RAFX10** — Power Rated Right Angle Fitting \(page K13\)](#)

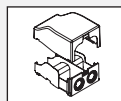

S [EEFX** — Power Rated/1" Bend Radius Entrance End Fitting \(page K13\)](#)

LD2P10 Configurations

Exploded view 1

	Components Required	See page
A.	PAN-NET® Connectivity.	—
B.	FP2RC = Double Gang Rectangular Electrical and Two Communication Insert Faceplate (screws included).	J10
C.	ERU20 = 20A Rectangular Electrical Outlet (screws included).	J11
D.	JBP2S = Power Rated Double Gang Three-Piece Divided Box (screws included).	J8

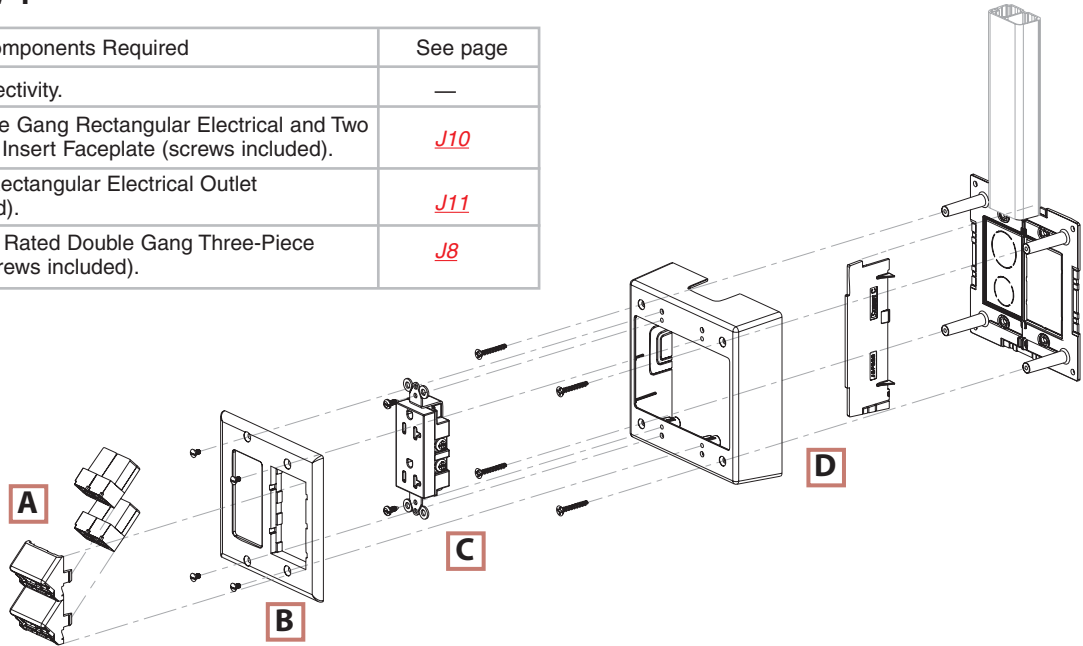

Exploded view 2

	Components Required	See page
A.	JBD2 = Double Gang Pass Through Divider for LD2P10 Raceway.	J8
B.	JBP2D = Power Rated Double Gang Two-Piece Deep Box.	J8
C.	ERU20 = 20A Rectangular Electrical Outlet (screws included).	J11
D.	PAN-NET® Connectivity.	—
E.	CPG2G = Double Gang Rectangular Screw-On Faceplate (screws included).	J10

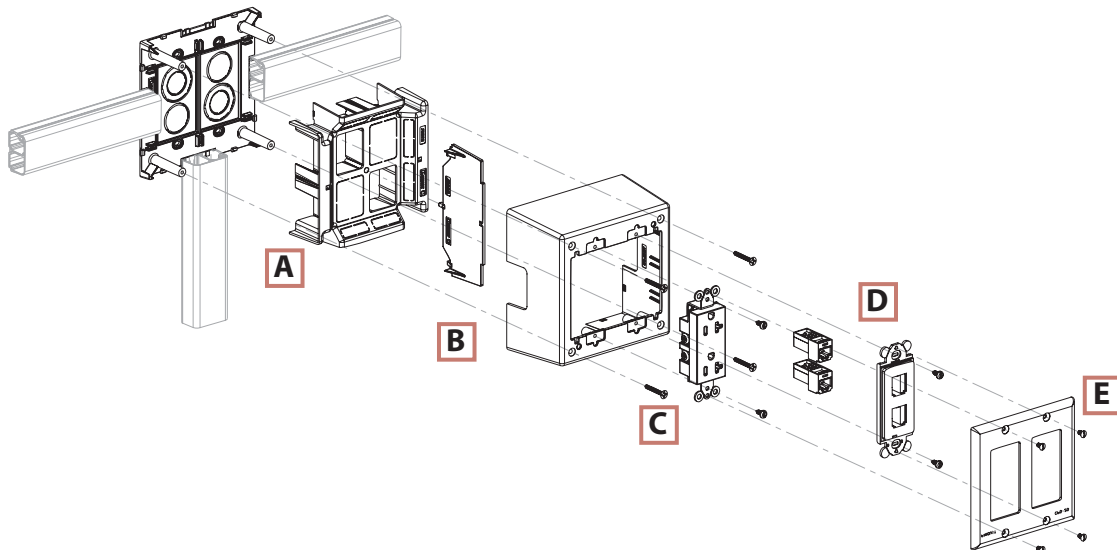

LD2P10 Configurations (Continued)

Exploded view 3

	Components Required	See page
A.	UICFPSE2 = <i>ULTIMATE ID™</i> Two-Position Executive Sloped Faceplate.	H3
B.	<i>PAN-NET®</i> Connectivity.	—
C.	JBP1D = Power Rated Single Gang Two-Piece Deep Box (screws included).	J8
D.	JBD1 = Single Gang Pass Through Divider for LD2P10 Raceway.	J8

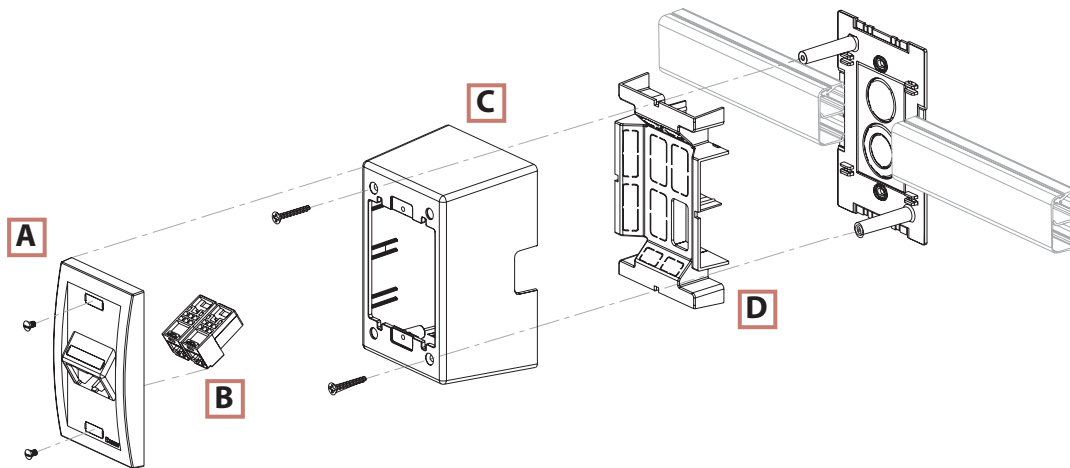

LD Profile Raceway Roadmap

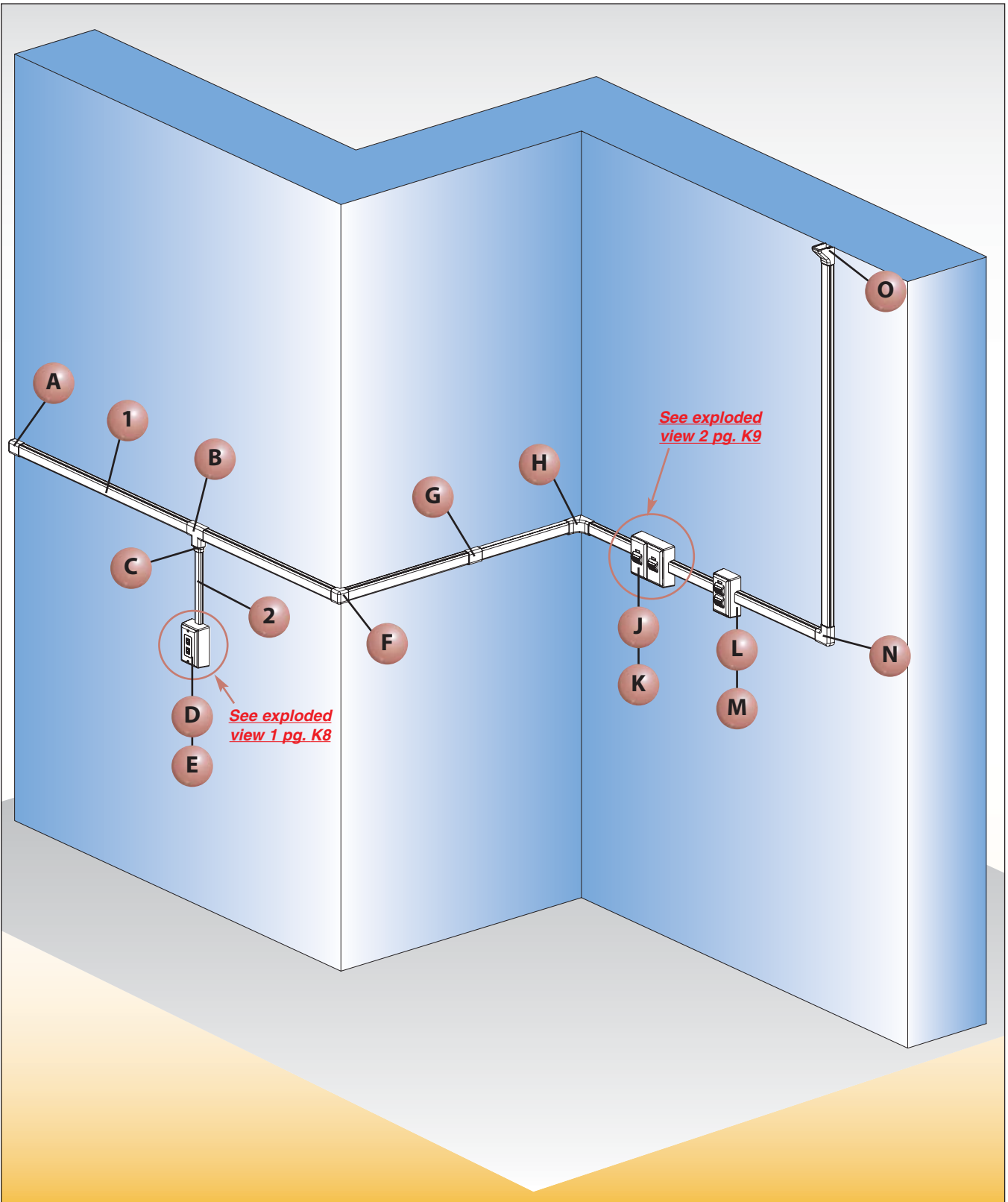



1 [LD10 Raceway \(page K14\)](#)

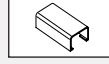

G [CF10** — Coupler Fitting \(page K17\)](#)



2 [LD5 Raceway \(page K14\)](#)

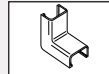

H [ICF10** — Inside Corner Fitting \(page K17\)](#)

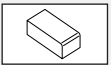

A [ECF10** — End Cap Fitting \(page K17\)](#)

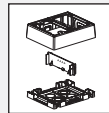

J [JBP2FS** — FAST-SNAP™ Double Gang Power Rated Surface Mount Outlet Box \(page J2\)](#)

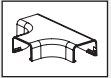

B [TF10** — Tee Fitting \(page K17\)](#)

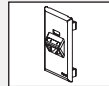

K [UIT70FV2** — ULTIMATE ID™ Sloped Vertical Snap-On Faceplates Two-Position \(page H5\)](#)



C [RF10X5** — Reducer Fitting \(page K17\)](#)

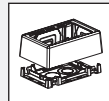

L [JB1FS** — FAST-SNAP™ Single Gang Surface Mount Outlet Box \(page J2\)](#)

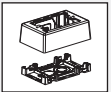

D [JBX3510** — Single Gang Two-Piece Snap-Together Box \(page J7\)](#)



M [UIT70FV4** — ULTIMATE ID™ Sloped Vertical Snap-On Faceplates Four Position \(page H5\)](#)

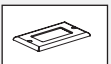

E [CPG** — Single Gang Rectangular Screw-On Faceplate \(page J10\)](#)

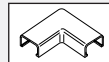

N [RAF10** — Right Angle Fitting \(page K17\)](#)

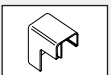

F [OCF10** — Outside Corner Fitting \(page K17\)](#)



O [DCF10** — Drop Ceiling/Entrance End Fitting \(page K17\)](#)

LD Configurations

Exploded view 1

	Components Required	See page
A.	CPG = Single Gang Rectangular Screw-On Faceplate (screws included).	J10
B.	PAN-NET® Connectivity.	—
C.	JBX3510 = Single Gang Two-Piece Snap Together Box.	J7

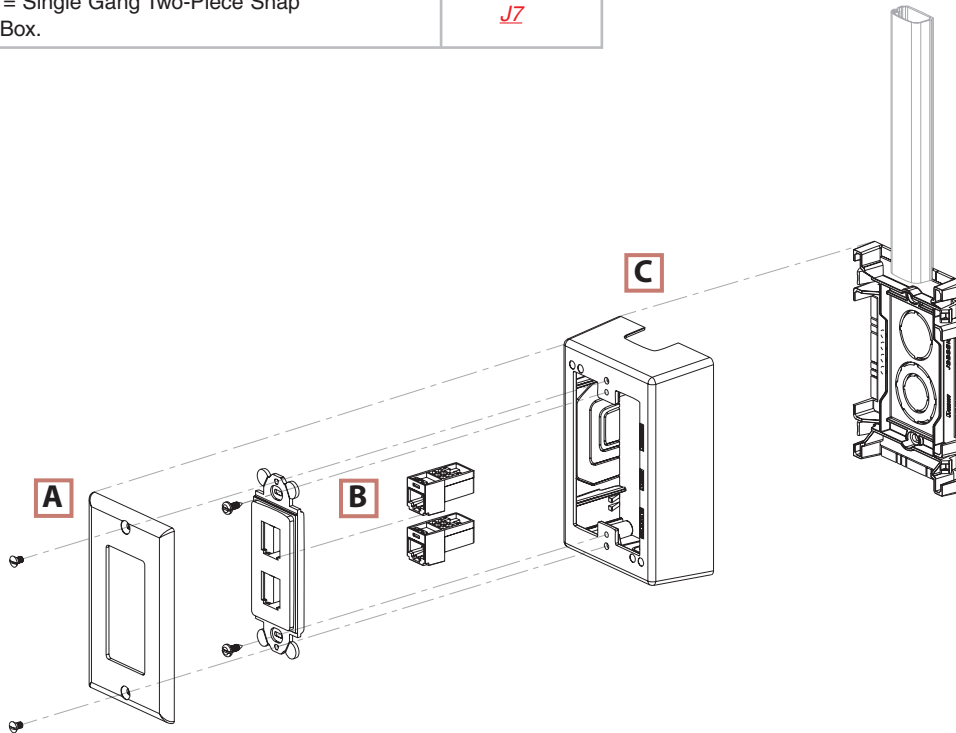

LD Configurations (Continued)

Exploded view 2

	Components Required	See page
A.	UIT70FV2 = <i>ULTIMATE ID™</i> Sloped Vertical Snap-On Faceplate — Two Port.	<i>H5</i>
B.	<i>PAN-NET®</i> Connectivity.	—
C.	JBP2FS = <i>FAST-SNAP™</i> Double Gang Power Rated Surface Mount Outlet Box.	<i>J2</i>

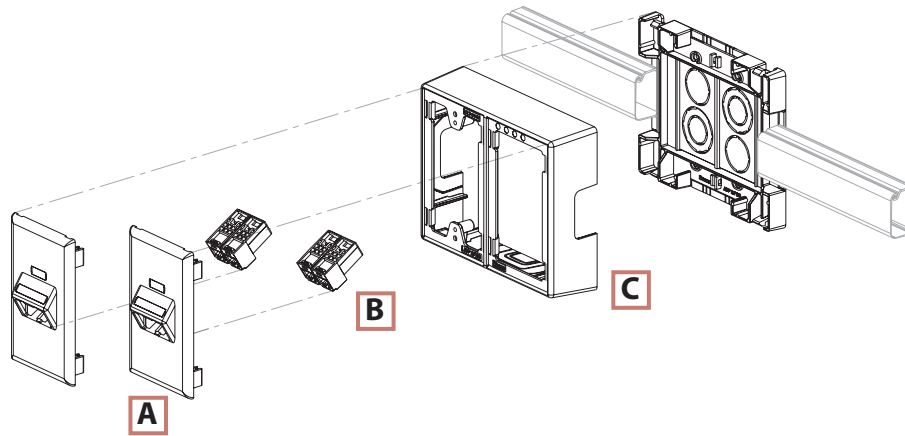

LDP Profile Raceway Roadmap

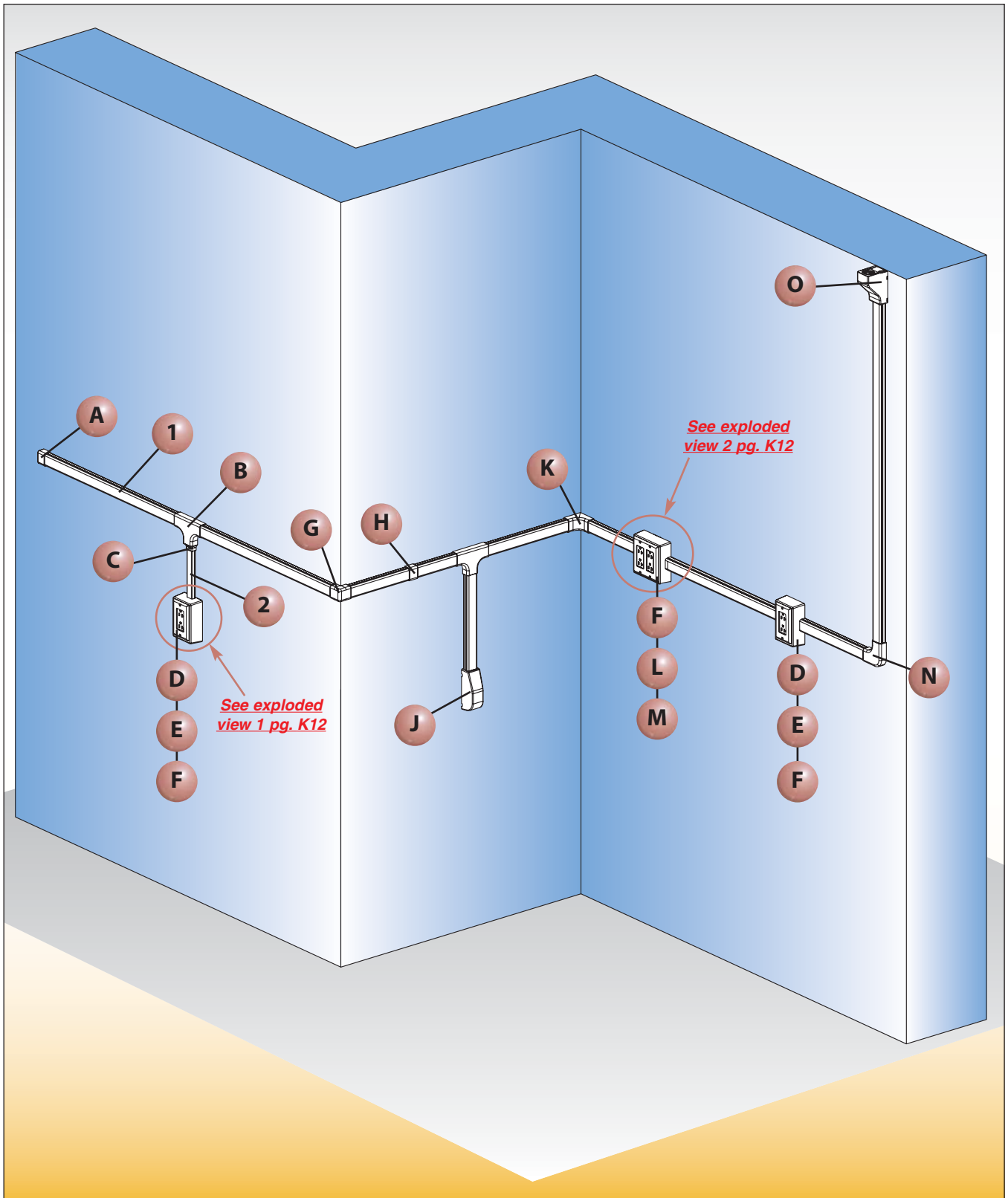



1 [LDP10 Raceway \(page K15\)](#)



G [OCFC10** — Power Rated Outside Corner Fitting \(page K19\)](#)



2 [LDP5 Raceway \(page K15\)](#)

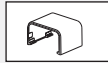

H [CFX10** — Power Rated/1" Bend Radius Coupler Fitting \(page K19\)](#)



A [ECFX10** — Power Rated/1" Bend Radius End Cap Fitting \(page K19\)](#)

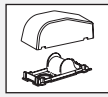

J [RAEFX** — Power Rated/1" Bend Radius Right Angle Entrance End Fitting \(page K19\)](#)

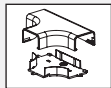

B [TFX10** — Power Rated/1" Bend Radius Tee Fitting \(page K19\)](#)

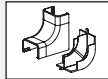

K [ICFX10** — Power Rated Inside Corner Fitting \(page K19\)](#)



C [RFX105** — Power Rated/1" Bend Radius Reducer Fitting \(page K19\)](#)

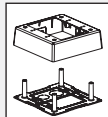

L [JBP2** — Power Rated Double Gang Two-Piece Box \(page J8\)](#)

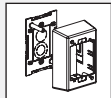

D [JBP1** — Power Rated Single Gang Two-Piece Box \(page J8\)](#)

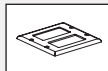

M [CPG**-2G — Double Gang Rectangular Screw-On Faceplates \(page J10\)](#)

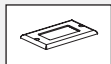

E [CPG** — Single Gang Rectangular Screw-On Faceplate \(page J10\)](#)

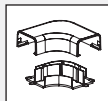

N [RAFX10** — Power Rated Right Angle Fitting \(page K19\)](#)

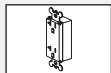

F [ERU20** — 20 A Rectangular Electrical Outlet \(page J11\)](#)

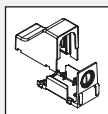

O [DCEFX** — Power Rated/1" Bend Radius Drop Ceiling Entrance End Fitting \(page K19\)](#)

LDP Configurations

Exploded view 1

	Components Required	See page
A.	CPG = Single Gang Rectangular Screw-On Faceplate (screws included).	J10
B.	ERU20 = 20A Rectangular Electrical Outlet (screws included).	J11
C.	JBP1 = Power Rated Single Gang Two-Piece Box (screws included).	J8

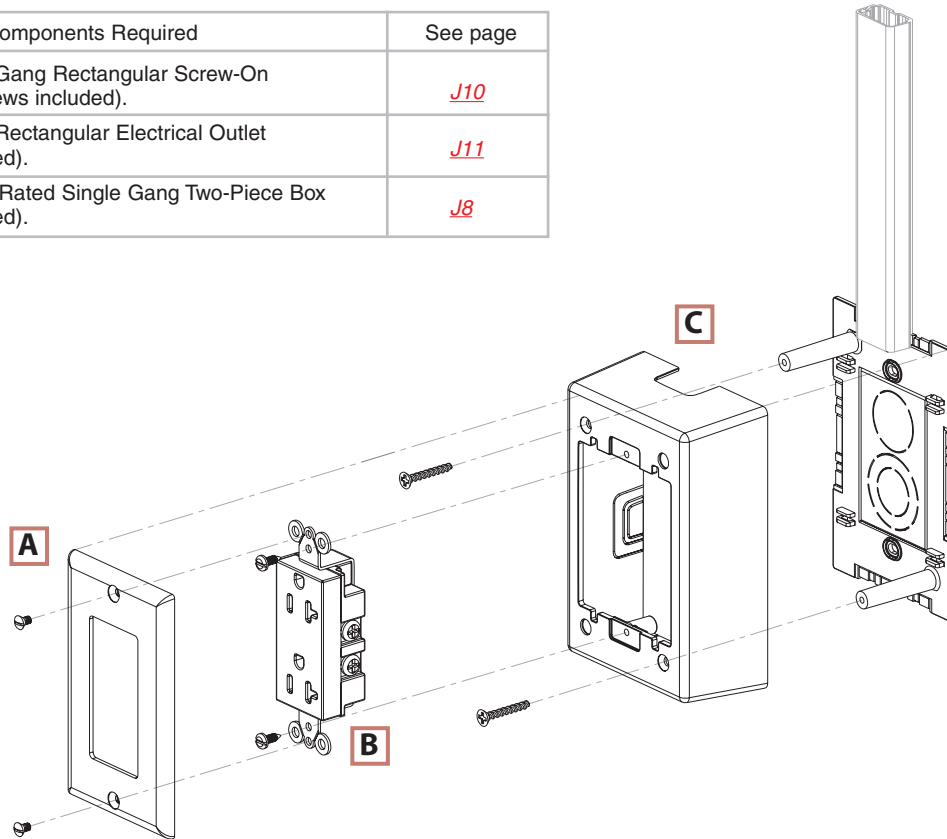

Exploded view 2

	Components Required	See page
A.	CPG**2G = Double Gang Rectangular Screw-On Faceplate (screws included).	J10
B.	ERU20 = 20A Rectangular Electrical Outlet (screws included).	J11
C.	JBP2 = Power Rated Double Gang Two-Piece Box (screws included).	J8

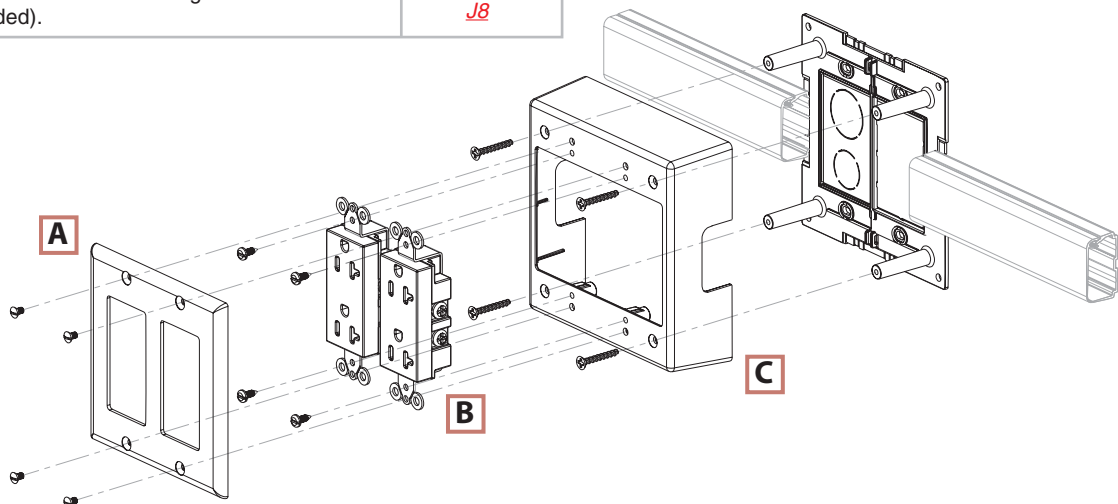



PAN-WAY® Type LD2P10 Multi-Channel Surface Raceway System

- UL and CSA rated 600V; meets UL5A and CSA C22.2 No. 62.1-03 standards
- Routes power and data together
- One-piece hinged design allows cables to be laid in
- Tamper resistant
- Factory applied adhesive backing speeds installation
- FT-4 Rated for Canada
- Terminates using JBP1D, JBP2D, JBP2FS, or JBP2S surface mount outlet box solutions

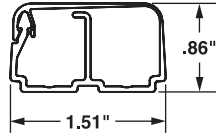

Left Internal Area = .43 Sq. In.
Right Internal Area = .50 Sq. In.



LD2P10

Part Number	Part Description	Raceway Size	Color‡	Length (ft)	Std. Ctn. Qty.
LD2P10IW8-A	Two channel tamper resistant one-piece latching surface raceway. Supplied with pre-applied adhesive backed tape.	1.51" x .86"	Off White	8	160
LD2P10IW10-A	Available in 8' and 10' lengths.			10	200

LD2P Raceway requires screw mounting if it is being used for power cabling applications. Order number of feet required in multiples of standard length increments.
‡ For other colors replace IW (Off White) with EI (Electric Ivory), IG (International Gray), or WH (White).



Multi-Channel Fittings for LD2P10

- Multi-channel fittings for LD2P10 are designed to maintain the TIA/EIA 568-B and 569-B required minimum bend radius for high performance copper and fiber optic cabling systems



CFX10



RAFX10



ICFX10



OCFX10



TFXD10

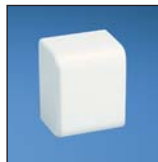

ECFX10



EEFX

Part Number	Part Description	Color‡	Std. Pkg. Qty.
CFX10IW-X	Coupler Fitting for use with LD10, LDP10 and LD2P10 Raceway.	Off White	10
RAFX10IW-X	Right Angle Fitting for use with LDP10 and LD2P10 Raceway.	Off White	10
ICFX10IW-X	Inside Corner Fitting for use with LDP10 and LD2P10 Raceway.	Off White	10
OCFX10IW-X	Outside Corner Fitting for use with LDP10 and LD2P10 Raceway.	Off White	10
TFXD10IW-X	Tee Fitting with divided insert to maintain separation of power and data cabling. For use with LD2P10 Raceway.	Off White	10
ECFX10IW-X	End Cap Fitting for use with LDP10 and LD2P10 Raceway.	Off White	10
EEFXIW	Entrance End Fitting for LD2P10 Raceway. Breakouts for 1/2", 3/4", and 1" diameter conduit.	Off White	1

‡ For other colors replace IW (Off White) with EI (Electric Ivory), IG (International Gray) or WH (White).

PAN-WAY® LD Surface Raceway System

- For routing data and low voltage cabling
- One-piece hinged design allows cables to be laid in
- Factory applied adhesive backing speeds installation

- FT-4 Rated for Canada
- Terminates using surface mount outlet box solutions or *MINI-COM®* Surface Mount Boxes

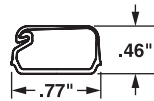

Internal Area = .21 Sq. In.

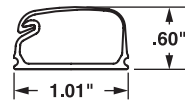

Internal Area = .38 Sq. In.

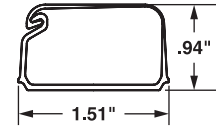

Internal Area = 1.00 Sq. In.



LD3



LD5



LD10

Part Number	Part Description	Raceway Size	Color‡	Length (ft)	Std. Ctn. Qty.
LD3 — Surface Raceway					
LD3IW6-A	One-piece latching surface raceway. Supplied with pre-applied adhesive backed tape. Available in 6', 8', and 10' lengths.	.77" x .46"	Off White	6	120
LD3IW8-A				8	160
LD3IW10-A				10	200
LD5 — Surface Raceway					
LD5IW6-A	One-piece latching surface raceway. Supplied with pre-applied adhesive backed tape. Available in 6', 8', and 10' lengths.	1.00" x .60"	Off White	6	120
LD5IW8-A				8	160
LD5IW10-A				10	200
LD10 — Surface Raceway					
LD10IW6-A	One-piece latching surface raceway. Supplied with pre-applied adhesive backed tape. Available in 6', 8', and 10' lengths.	1.51" x .94"	Off White	6	120
LD10IW8-A				8	160
LD10IW10-A				10	200

‡ For other colors replace IW (Off White) with EI (Electric Ivory), IG (International Gray), or WH (White). Order number of feet required in multiples of standard length increments.



PAN-WAY® LDP Surface Raceway System

- UL and CSA rated 600V; meets UL5A and CSA C22.2 No. 62.1-03 standards
- One-piece hinged design allows cables to be laid in
- Tamper resistant

- Factory applied adhesive backing speeds installation
- FT-4 Rated for Canada
- Terminates using surface mount outlet box solutions or *MINI-COM*® Surface Mount Boxes

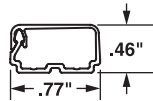

Internal Area = .21 Sq. In.

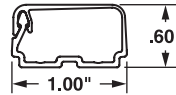

Internal Area = .38 Sq. In.

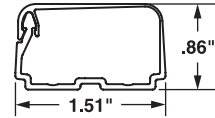

Internal Area = .98 Sq. In.



LDP3



LDP5

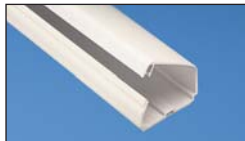

LDP10

Part Number	Part Description	Raceway Size	Color‡	Length (ft)	Std. Ctn. Qty.
LDP3 — Surface Raceway					
LDP3IW8-A	Tamper resistant one-piece latching surface raceway. Supplied with pre-applied adhesive backed tape. Available in 8' and 10' lengths.	.77" x .46"	Off White	8	160
LDP3IW10-A				10	200
LDP5 — Surface Raceway					
LDP5IW8-A	Tamper resistant one-piece latching surface raceway. Supplied with pre-applied adhesive backed tape. Available in 8' and 10' lengths.	1.00" x .60"	Off White	8	160
LDP5IW10-A				10	200
LDP10 — Surface Raceway					
LDP10IW8-A	Tamper resistant one-piece latching surface raceway. Supplied with pre-applied adhesive backed tape. Available in 8' and 10' lengths.	1.51" x .86"	Off White	8	160
LDP10IW10-A				10	200

LDP Raceway requires screw mounting for power cabling applications.

Order number of feet required in multiples of standard length increments.

‡ For other colors replace IW (Off White) with EI (Electric Ivory), IG (International Gray), or WH (White).

UL® PAN-WAY® LDS Surface Raceway System

- UL and CSA rated 600V; meets UL5A and CSA C22.2 No. 62.1-03 standards
- Tamper resistant non-hinged design
- Factory applied adhesive backing speeds installation
- FT-4 Rated for Canada
- Type LDS is **the only non-metallic raceway that is bendable** in low voltage applications to route around and over obstructions
- LDS Raceway requires screw mounting using the LMD mounting straps for power cabling installations
- Terminates using surface mount outlet box solutions or *MINI-COM®* Surface Mount Boxes

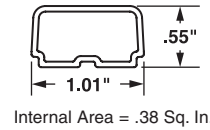
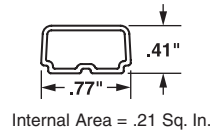

LDS3



LDS5

LMD3
LMD5

Part Number	Part Description	Raceway Size	Color‡	Length (ft)	Std. Ctn. Qty.
LDS3 — Surface Raceway					
LDS3IW10-A	Tamper resistant one-piece surface raceway. Supplied with pre-applied adhesive backed tape. Available in 10' lengths.	.77" x .41"	Off White	10	200
LDS5 — Surface Raceway					
LDS5IW10-A	Tamper resistant one-piece surface raceway. Supplied with pre-applied adhesive backed tape. Available in 10' lengths.	1.01" x .55"	Off White	10	200
Mounting Straps					
LMD3IW-Q	For use with LDS3 Raceway.	Size 3	Off White	—	100
LMD5IW-Q	For use with LDS5 Raceway.	Size 5	Off White	—	100

‡ For other colors replace IW (Off White) with EI (Electric Ivory), IG (International Gray) or WH (White).
Order number of feet required in multiples of standard length increments.

Method for Bending Type LDS Raceway (Low Voltage Applications)



STEP 1: Slide 18" to 30" section of LDS Raceway into PVC pipe heating blanket.
*(Recommended blanket designed for bending 1/2" to 1 1/2" PVC conduit.)



STEP 2: Allow section to heat approximately 2-3 minutes. Raceway will be soft and pliable, but should not stretch. (Time will vary with blanket temperature and raceway size.)



STEP 3: Remove raceway section from blanket and hold in desired position until the raceway cools. Install mounting straps immediately.

*Heating blanket not offered by PANDUIT®

Standard Fittings for Low Voltage Applications

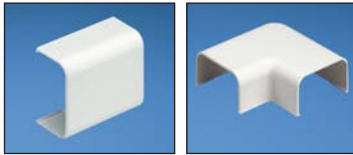

CF

RAF

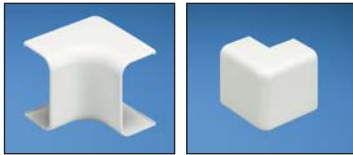

ICF

OCF

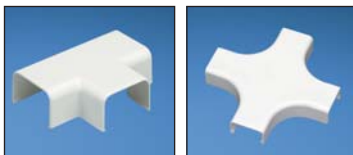

TF

CRFC

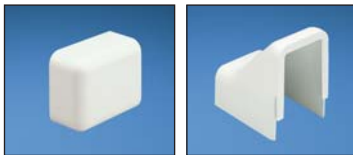

ECF

DCF



RF

Part Number	Part Description	Color†	Std. Pkg. Qty.
CF3IW-E	Coupler Fitting for use with LD3 Raceway.	Off White	20
CF5IW-E	Coupler Fitting for use with LD5 Raceway.	Off White	20
CF10IW-X	Coupler Fitting for use with LD10 Raceway.	Off White	10
RAF3IW-E	Right Angle Fitting for use with LD3 Raceway.	Off White	20
RAF5IW-E	Right Angle Fitting for use with LD5 Raceway.	Off White	20
RAF10IW-X	Right Angle Fitting for use with LD10 Raceway.	Off White	10
ICF3IW-E	Inside Corner Fitting for use with LD3 Raceway.	Off White	20
ICF5IW-E	Inside Corner Fitting for use with LD5 Raceway.	Off White	20
ICF10IW-X	Inside Corner Fitting for use with LD10 Raceway.	Off White	10
OCF3IW-E	Outside Corner Fitting for use with LD3 Raceway.	Off White	20
OCF5IW-E	Outside Corner Fitting for use with LD5 Raceway.	Off White	20
OCF10IW-X	Outside Corner Fitting for use with LD10 Raceway.	Off White	10
TF3IW-E	Tee Fitting for use with LD3 Raceway.	Off White	20
TF5IW-E	Tee Fitting for use with LD5 Raceway.	Off White	20
TF10IW-X	Tee Fitting for use with LD10 Raceway.	Off White	10
CRFC5IW-X	Four Way Cross Fitting for use with LD5, LDP5 and LDS5 Raceway.	Off White	10
ECF3IW-E	End Cap Fitting for use with LD3 Raceway.	Off White	20
ECF5IW-E	End Cap Fitting for use with LD5 Raceway.	Off White	20
ECF10IW-X	End Cap Fitting for use with LD10 Raceway.	Off White	10
DCF3IW-X	Drop Ceiling/Entrance End Fitting for use with LD3 Raceway.	Off White	10
DCF5IW-X	Drop Ceiling/Entrance End Fitting for use with LD5 Raceway.	Off White	10
DCF10IW-X	Drop Ceiling/Entrance End Fitting for use with LD10 Raceway.	Off White	10
RF5X3IW-E	Reducer Fitting for LD Raceway from size 5 to size 3. For use with LD5 and LD3 Raceway.	Off White	20
RF10X3IW-X	Reducer Fitting for LD Raceway from size 10 to size 3. For use with LD3 and LD10 Raceway.	Off White	10
RF10X5IW-X	Reducer Fitting for LD Raceway from size 10 to size 5. For use with LD5 and LD10 Raceway.	Off White	10

† For other colors replace IW (Off White) with EI (Electric Ivory), IG (International Gray), or WH (White).



One Inch Bend Radius Fittings for TIA/EIA Compliance

- One inch bend radius fittings are designed to maintain the TIA/EIA 568-B and 569-B required minimum bend radius for high performance copper and fiber optic cabling systems

	Part Number	Part Description	Color‡	Std. Pkg. Qty.
Cove	 CFX	CFX3IW-X Coupler Fitting for use with LD3, LDP3 and LDS3 Raceway.	Off White	10
	 RAFC	CFX5IW-X Coupler Fitting for use with LD5, LDP5 and LDS5 Raceway.	Off White	10
		CFX10IW-X Coupler Fitting for use with LD10, LDP10 and LD2P10 Raceway.	Off White	10
TG-70	 ICFC	RAFC3IW-X Right Angle Fitting for use with LD3, LDP3 and LDS3 Raceway.	Off White	10
	 OCFX	RAFC5IW-X Right Angle Fitting for use with LD5, LDP5 and LDS5 Raceway.	Off White	10
		RAFC10IW-X Right Angle Fitting for use with LD10 and LDP10 Raceway.	Off White	10
T-70 & Twin-70	 ICFC	ICFC3IW-X Inside Corner Fitting for use with LD3, LDP3 and LDS3 Raceway.	Off White	10
	 OCFX	ICFC5IW-X Inside Corner Fitting for use with LD5, LDP5 and LDS5 Raceway.	Off White	10
		ICFC10IW-X Inside Corner Fitting for use with LD10 and LDP10 Raceway.	Off White	10
T-45	 TFC	OCFX3IW-X Outside Corner Fitting for use with LDP3 and LDS3 Raceway.	Off White	10
	 CRFC5	OCFX5IW-X Outside Corner Fitting for use with LDP5 and LDS5 Raceway.	Off White	10
		OCFX10IW-X Outside Corner Fitting for use with LDP10 and LD2P10 Raceway.	Off White	10
Ultimate ID System	 ECFX	TFC3IW-X Tee Fitting for use with LD3, LDP3 and LDS3 Raceway.	Off White	10
	 DCEFX	TFC5IW-X Tee Fitting for use with LD5, LDP5 and LDS5 Raceway.	Off White	10
		TFC10IW-X Tee Fitting for use with LD10 and LDP10 Raceway.	Off White	10
Faceplates, Boxes & Labeling	 RAEFX	CRFC5IW-X Four Way Cross Fitting for use with LD5, LDP5 and LDS5 Raceway.	Off White	10
	 RFX	ECFX3IW-X End Cap Fitting for use with LDP3 and LDS3 Raceway.	Off White	10
		ECFX5IW-X End Cap Fitting for use with LDP5 and LDS5 Raceway.	Off White	10
LD Profile		ECFX10IW-X End Cap Fitting for use with LDP10 and LD2P10 Raceway.	Off White	10
		DCEFXIW-X Drop Ceiling/Entrance End Fitting for use with LD3, LDP3, LDS3, LD5, LDP5, LDS5, LD10 and LDP10 Raceway. Use CA3 or CA5 adapters for LD3 or LD5 Profile Raceway.	Off White	10
		RAEFXIW-X Right Angle/Entrance End Fitting for use with LD3, LDP3, LDS3, LD5, LDP5, LDS5, LD10, and LDP10 Raceways. CA3 or CA5 adapters for LD3 or LD5 Profile Raceway.	Off White	10
T130		RFX53IW-X Reducer Fitting for use with LD3, LDP3, LDS3, LD5, LDP5 and LDS5 Raceway.	Off White	10
		RFX103IW-X Reducer Fitting for use with LD3, LDP3, LDS3, LD10 and LDP10 Raceway.	Off White	10
		RFX105IW-X Reducer Fitting for use with LD5, LDP5, LDS5, LD10 and LDP10 Raceway.	Off White	10

‡ For other colors replace IW (Off White) with EI (Electric Ivory), IG (International Gray), or WH (White).



Power Rated Fittings for Power to 600V — LDP/LDS/LD2P Raceway Only



CFX

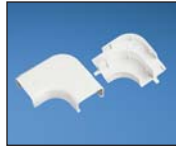

RAFX



ICFX



OCFC



TFX



CRFX

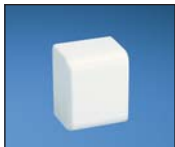

ECFX



DCEFX



RAEFX



RFX

Part Number	Part Description	Color‡	Std. Pkg. Qty.
CFX3IW-X	Coupler Fitting for use with LD3, LDP3 and LDS3 Raceway.	Off White	10
CFX5IW-X	Coupler Fitting for use with LD5, LDP5 and LDS5 Raceway.	Off White	10
CFX10IW-X	Coupler Fitting for use with LD10, LDP10 and LD2P10 Raceway.	Off White	10
RAFX3IW-X	Right Angle Fitting for use with LDP3 and LDS3 Raceway.	Off White	10
RAFX5IW-X	Right Angle Fitting for use with LDP5 and LDS5 Raceway.	Off White	10
RAFX10IW-X	Right Angle Fitting for use with LDP10 and LD2P10 Raceway.	Off White	10
ICFX3IW-X	Inside Corner Fitting for use with LDP3 and LDS3 Raceway.	Off White	10
ICFX5IW-X	Inside Corner Fitting for use with LDP5 and LDS5 Raceway.	Off White	10
ICFX10IW-X	Inside Corner Fitting for use with LDP10 and LD2P10 Raceway.	Off White	10
OCFC3IW-X	Outside Corner Fitting for use with LDP3 and LDS3 Raceway.	Off White	10
OCFC5IW-X	Outside Corner Fitting for use with LDP5 and LDS5 Raceway.	Off White	10
OCFC10IW-X	Outside Corner Fitting for use with LDP10 Raceway only.	Off White	10
TFX3IW-X	Tee Fitting for use with LDP3 and LDS3 Raceway.	Off White	10
TFX5IW-X	Tee Fitting for use with LDP5 and LDS5 Raceway.	Off White	10
TFX10IW-X	Tee Fitting for use with LDP10 Raceway only.	Off White	10
CRFX5IW-X	Four Way Cross Fitting for use with LD5, LDP5 and LDS5 Raceway.	Off White	10
ECFX3IW-X	End cap fitting for use with LDP3 and LDS3 Raceway.	Off White	10
ECFX5IW-X	End cap fitting for use with LDP5 and LDS5 Raceway.	Off White	10
ECFX10IW-X	End Cap Fitting for use with LDP10 and LD2P10 Raceway.	Off White	10
DCEFXIW-X	Drop Ceiling/Entrance End Fitting for use with LD3, LDP3, LDS3, LD5, LDP5, LDS5, LD10 and LDP10 Raceway. Use CA3 or CA5 adapters for LD3 or LD5 Profile Raceway.	Off White	10
RAEFXIW-X	Right Angle/Entrance End Fitting for use with LD3, LDP3, LDS3, LD5, LDP5, LDS5, LD10 and LDP10 Raceways. CA3 or CA5 adapters for LD3 or LD5 Profile Raceway.	Off White	10
RFX53IW-X	Reducer Fitting for use with LD3, LDP3, LDS3, LD5, LDP5 and LDS5 Raceway.	Off White	10
RFX103IW-X	Reducer Fitting for use with LD3, LDP3, LDS3, LD10 and LDP10 Raceway.	Off White	10
RFX105IW-X	Reducer Fitting for use with LD5, LDP5, LDS5, LD10 and LDP10 Raceway.	Off White	10

‡ For other colors replace IW (Off White) with EI (Electric Ivory), IG (International Gray), or WH (White).



Quick Wire Fill Capacities for LD Profile Raceway

This information is to be used as a guide in selecting the proper size raceway. The maximum amounts may vary according to the wire installation methods, straightness of wires, etc.



LD3	LD5	LD10
.21 in ²	.38 in ²	1.00 in ²



LDP3	LDP5	LDP10
.21 in ²	.38 in ²	98 in ²

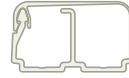

LD2P10 — Left	LDP210 — Right
.43 in ²	.50 in ²



LDS3	LDS5
.21 in ²	.38 in ²

SPEC = 40% wire fill — The recommended design in cable capacity, leaves room for future moves, adds, and changes.

MAX for Data = 60% wire fill — The maximum cable quantity based on cable interweaving and packing factors.

MAX for Power wire fill — The maximum of electrical cables based on UL temperature rise test.

Raceway Type & Configuration	Fill Area (in ²)	Electrical Cables			Data Grade Cable		Data Grade Cable		Coax Cable		Fiber Optic Cable	
		14 AWG	12 AWG	10 AWG	24 AWG/UTP CM		24 AWG/UTP CM		RG6		2 Strand	
		THHN/T90			Cat 5e (4pr)		Cat 6 (4pr)					
		.105	.122	.153	DIA. = .217		DIA. = .250		DIA. = .275		DIA. = .175	
		FILL			FILL		FILL		FILL		FILL	
MAX	MAX	MAX	SPEC	MAX	SPEC	MAX	SPEC	MAX	SPEC	MAX	MAX	
(UL Temp Rise Test)			(40%)	(60%)	(40%)	(60%)	(40%)	(60%)	(40%)	(60%)	(40%)	(60%)
LD3	.21	—	—	—	2	3	1	2	1	2	4	5
LD5	.38	—	—	—	4	6	3	4	2	3	6	9
LD10	1.00	—	—	—	10	16	8	12	5	8	16	24
LDP3	.21	9	7	4	2	3	1	2	1	2	3	5
LDP5	.38	14	12	8	4	6	3	4	2	3	6	9
LDP10	.98	18	18	16	10	15	7	11	5	8	16	16
LD2P10-Left Channel.	.43	14	11	8	4	6	3	5	2	3	7	11
LD2P10-Right Channel.	.50	—	—	—	5	8	4	6	3	4	8	12
LDS3	.21	9	6	4	2	3	1	2	1	2	3	5
LDS5	.38	10	8	5	4	6	3	4	2	3	6	9

Floor Guard

- Accessory to route cables over carpet, concrete, or tile to prevent tripping
- Flexible vinyl material can be easily cut to specific lengths
- Cables route through underside of product



FG1
FG3

Part Number	Part Description	Color‡	Std. Pkg. Qty.
FG1 — For Single Twisted Pair Cables			
FG1EI6-A	Flexible vinyl material used to route cabling over carpet, tile, and concrete. Product available in 6' and 50' rolls.	Electric Ivory	1
FG1EI50-A		Electric Ivory	1
FG3 — For Multiple or Larger Cables			
FG3EI6S-A	Flexible vinyl material used to route cabling over carpet, tile, and concrete. Product available in 6' and 50' rolls.	Electric Ivory	30
FG3EI50-A		Electric Ivory	30

Mounting tape is pre-applied only to FG3 in 6' lengths.

‡ For other colors replace EI (Electric Ivory) with BR (Brown), YL (Safety Yellow), or BL (Black).

PAN-WAY® Surface Raceway Cutting Tool



Part Number	Part Description	Std. Pkg. Qty.	Std. Ctn. Qty.
SRT	Used to cut all LD Profile Raceway. Leaves a clean burr-free finish on raceway. Can also be used to cut plastic conduit.	1	10

System Overview

Quick Selection Guide

Office Furniture

Cove

TG-70

T-70 & Twin-70

T-45

Ultimate ID System

Faceplates, Boxes & Labeling

LD Profile

T130

Outlet Pole

Technical Info

Glossary & Index

Foam Tape

- Acrylic foam tape — Recommended for high temperature and outdoor applications (180° F) and exposure to UV light
- Rubber foam tape — Excellent quick tack designed for long term shear loads in indoor applications up to 120°



P32W2A2
P32W2R1

Part Number	Part Description	Color	Std. Pkg. Qty.	Std. Ctn. Qty.
1/32" Thick White Acrylic Adhesive				
P32W2A2-50-7	Foam Tape, 1/32" (thick) x .50" (wide) x 7 yards, acrylic adhesive.	White	1	100
P32W2A2-75-7	Foam Tape, 1/32" (thick) x .75" (wide) x 7 yards, acrylic adhesive.	White	1	60
P32W2A2-100-7	Foam Tape, 1/32" (thick) x 1" (wide) x 7 yards, acrylic adhesive.	White	1	50
P32W2A2-50-72	Foam Tape, 1/32" (thick) x .50" (wide) x 72 yards, acrylic adhesive.	White	1	9
P32W2A2-75-72	Foam Tape, 1/32" (thick) x .75" (wide) x 72 yards, acrylic adhesive.	White	1	7
P32W2A2-100-72	Foam Tape, 1/32" (thick) x 1" (wide) x 72 yards, acrylic adhesive.	White	1	5
1/32" Thick White Rubber Adhesive				
P32W2R1-50-7	Foam Tape, 1/32" (thick) x .50" (wide) x 7 yards, rubber adhesive.	White	1	100
P32W2R1-75-7	Foam Tape, 1/32" (thick) x .75" (wide) x 7 yards, rubber adhesive.	White	1	60
P32W2R1-100-7	Foam Tape, 1/32" (thick) x 1" (wide) x 7 yards, rubber adhesive.	White	1	50
P32W2R1-50-72	Foam Tape, 1/32" (thick) x .50" (wide) x 72 yards, rubber adhesive.	White	1	9
P32W2R1-75-72	Foam Tape, 1/32" (thick) x .75" (wide) x 72 yards, rubber adhesive.	White	1	7
P32W2R1-100-72	Foam Tape, 1/32" (thick) x 1" (wide) x 72 yards, rubber adhesive.	White	1	5
P32W2R1-150-72	Foam Tape, 1/32" (thick) x 1.5" (wide) x 72 yards, rubber adhesive.	White	1	4

LD/LDP/LD2P Raceway Installation Tool

- Serves as a guide for drill bit in screw mount applications
- Holds LD/LDP/LD2P Raceway open during installation



LDW**-V

Part Number	Part Description	Color	Std. Pkg. Qty.	Std. Ctn. Qty.
LDW10-V	Installation tool for use with type LD10, LDP10, LD2P10 Raceway.	Black	5	50
LDW5-V	Installation tool for use with type LD5, or LDP5 Raceway.	Black	5	50
LDW3-V	Installation tool for use with type LD3, or LDP3 Raceway.	Black	5	50

PAN-WAY® TYPE T130 NON-METALLIC SURFACE RACEWAY

PAN-WAY® T130 Multi-Channel Raceway provides a large capacity channel solution for routing low voltage, fiber optic, and/or power cabling along fixed perimeter walls. The T130 Raceway System consists of raceway base, cover, fittings, termination hardware, and accessories.

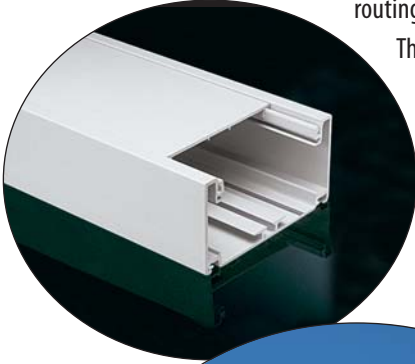

- Large capacity multi-channel raceway system
- Lightweight
- Tamper resistant

PANDUIT® T130 Raceway can mount NEMA standard 70mm screw-on faceplates or available snap-on and pre-punched covers, power and low voltage applications.

Type T130 Raceway Roadmap

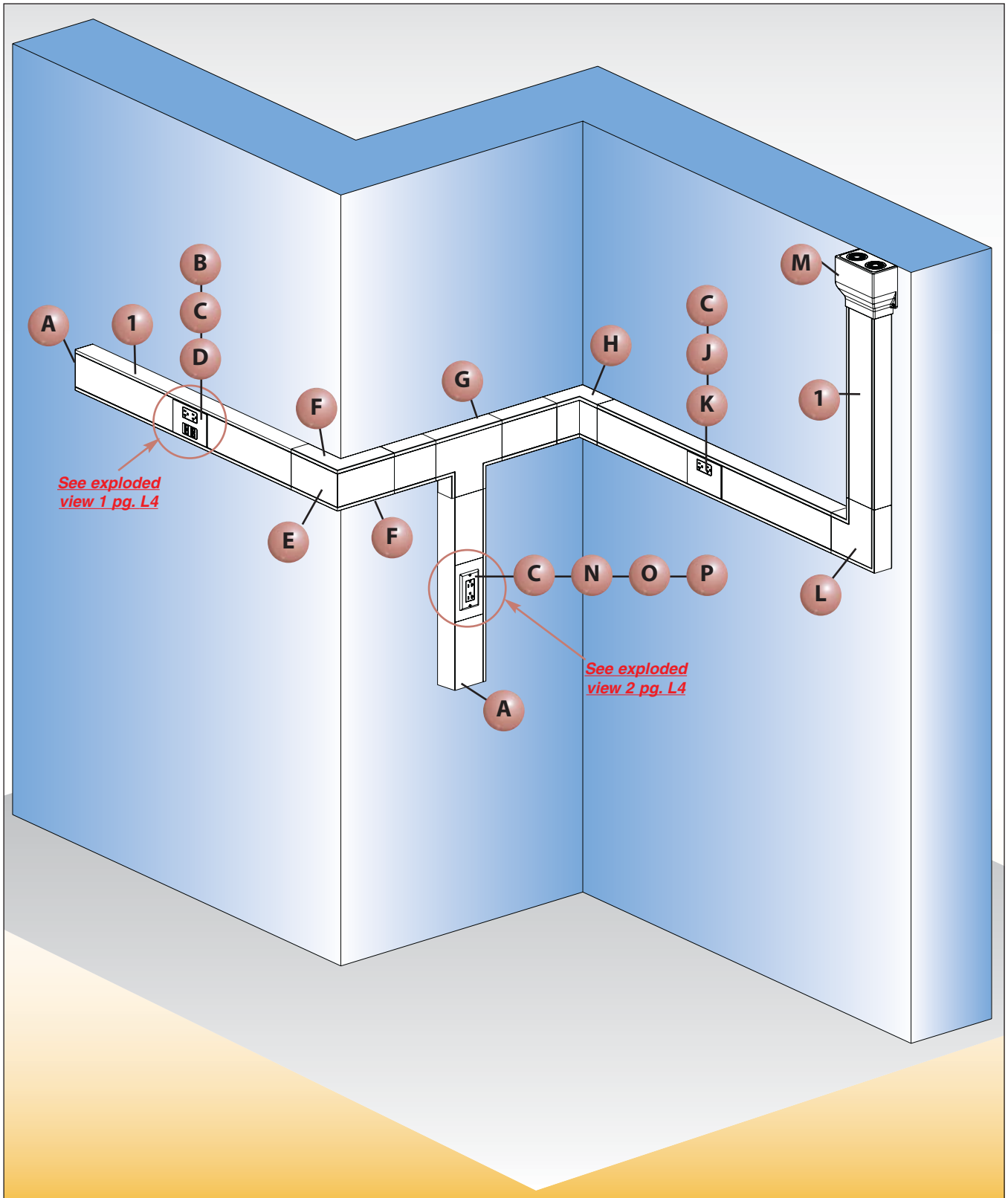

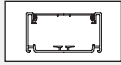

1 ***TB130*****, ***TC130***** — ***T130 Raceway Base and Cover (page L5)***



G ***TT130***** — ***T130 Tee Fitting (page L6)***

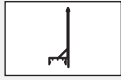

1 ***TD68*** — ***T130 Divider Wall (page L5)***



H ***TIC130***** — ***T130 Inside Corner Fitting (page L6)***

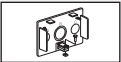

A ***TEC130***** — ***T130 End Cap Fitting (page L6)***

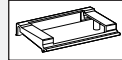

J ***T130DB-X*** — ***Hanging Device Bracket (page L8)***

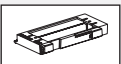

B ***T130DBD-X*** — ***“Gangable” Device Bracket (page L8)***

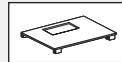

K ***T130RMC***** — ***Rectangular Electrical Device Snap-On Faceplate (page L8)***

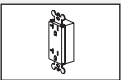

C ***ERU20***** — ***20A Rectangular Electrical Outlet (page J11)***



L ***TRA130***** — ***T130 Right Angle Fitting (page L6)***



D ***T130RMC2***** — ***Double Rectangular Electrical Device Snap-On Faceplate (page L8)***

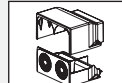

M ***TEE130***** — ***T130 Entrance End Fitting (page L6)***

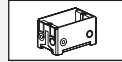

N ***TB5583-V*** — ***Type T Box (page L7)***



E ***TOCC130***** — ***T130 Outside Corner Fitting Cover (page L6)***

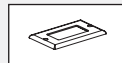

O ***CPG***** — ***Single Gang Rectangular Screw-On Faceplate (page J10)***

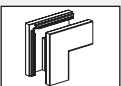

F ***TOCB130***** — ***T130 Outside Corner Fitting Base (page L6)***

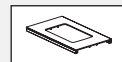

P ***T130G***** — ***Pre-Cut Cover (page L7)***

Type T130 Configurations

Exploded view 1

	Components Required	See page
A.	T130RMC2 = Double Rectangular Electrical Device Snap-On Faceplate.	L8
B.	EUR20 = 20A Rectangular Electrical Outlet.	—
C.	PAN-NET® Connectivity.	—
D.	T130DBD-X = “Gangable” Device Bracket.	L8

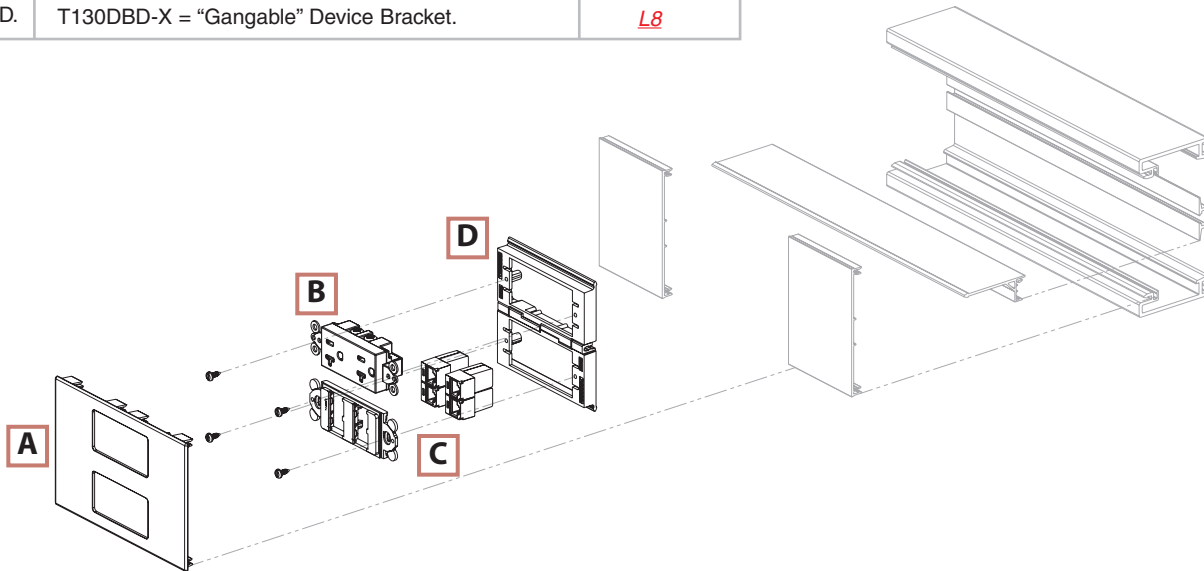

Exploded view 1

	Components Required	See page
A.	TB5583-V = Type T Box for T130 Raceway.	L7
B.	EUR20 = 20A Rectangular Electrical Outlet (screws included).	J11
C.	T130G = Pre-Cut Cover for Type T Box and NEMA Faceplates.	L7
D.	CPG = Single Gang Rectangular Screw-On Faceplate (screws included).	J10

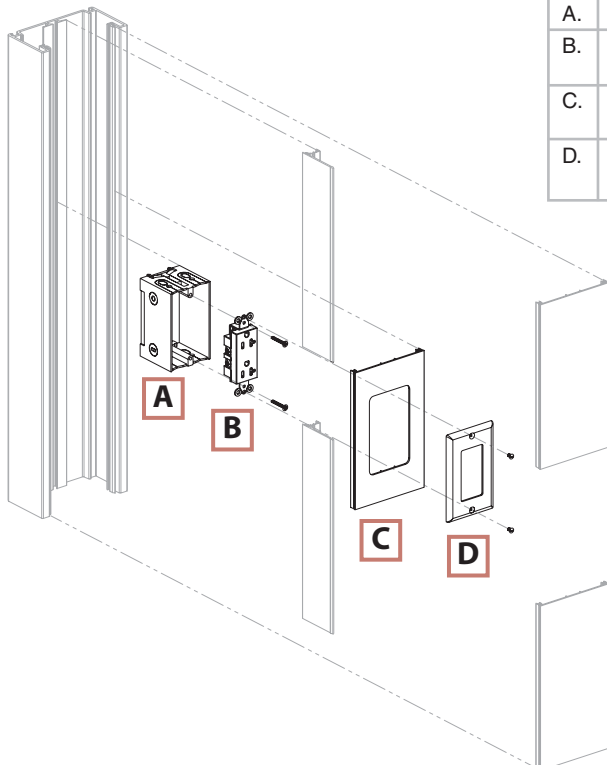



PAN-WAY® Type T130 Surface Raceway System

- UL & CSA rated 600V; meets UL5A and CSA C22.2 No. 62.1-03 standards
- Large capacity multi-channel system
- Tamper resistant cover latch design

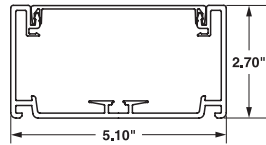

Internal Area = 10.96 Sq. In.



TB130 Base and TC130 Cover



TD68

Part Number	Part Description	Raceway Size	Color‡	Length (ft)	Std. Ctn. Qty.
Type T130 Raceway Base					
TB130IW8	T130 raceway base available in 8' and 10' lengths. Supplied with pre-punched mounting holes.	5.10" x 2.70"	Off White	8	32
TB130IW10				10	40
Type T130 Raceway Cover					
TC130IW8	T130 raceway cover available in 8' and 10' lengths.	-	Off White	8	64
TC130IW10				10	80
Type T Divider Wall					
TD688	Type T divider wall creates separate channels. Available in 8' and 10' lengths.	-	Gray	8	64
TD6810				10	80

‡ For other colors replace IW (Off White) with EI (Electric Ivory) or IG (International Gray). Order number of feet required in multiples of standard carton quantity.

PAN-WAY® Type T130 Raceway Fittings

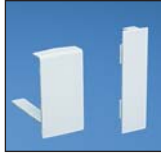

TCFC130
TCFB3070



TRA130

Part Number	Part Description	Color‡	Std. Pkg. Qty.	Std. Ctn. Qty.
TCFC130IW-X	Cover Coupler Fitting. Used to join sections of T130 Cover together.	Off White	10	100
TCFB3070IW-X	Base Coupler Fitting. Used to join sections of Type T130 Base together.	Off White	10	100
TRA130IW	Right Angle Fitting. Used to join sections of T130 Raceway at right angles.	Off White	1	10
TRA130IR	T130 Bend Radius Insert. Works with T130 Right Angle and Tee Fittings.	Gray	1	10
TIC130IW	Inside Corner Fitting. Used to join sections of T130 Raceway at inside corners.	Off White	1	10
TOCB130IW	Outside Corner Base Fitting. Used to join sections of T130 Raceway at outside corners.	Off White	1	10
TOCC130IW	Outside Corner Cover Fitting. Used to cover T130 Outside Corner Base.	Off White	1	10
TT130IW	Tee Fitting. Used to join sections of T130 Raceway at tee intersections.	Off White	1	10
T130TD	Divided Tee Insert. To be used with T130 Tee Fitting.	Gray	1	10
TEC130IW	End Cap Fitting. Conduit breakouts of 1/2" and 3/4".	Off White	1	10
TEE130IW	Entrance End Fitting. Conduit breakouts of 1/2", 3/4", 1", 1 1/2" and 2". Fitting accommodates entry from ceiling or wall.	Off White	1	10

‡ For other colors replace IW (Off White) with EI (Electric Ivory) or IG (International Gray).

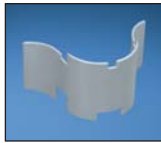

TRA130IR



TIC130

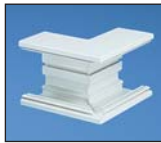

TOCB130

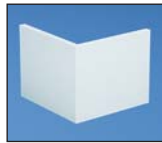

TOCC130



TT130



T130TD



TEC130



TEE130

Type T Raceway Accessories



TMB130-X

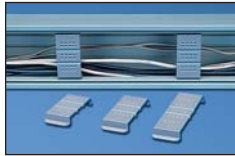

TWR130-X

Part Number	Part Description	Color	Std. Pkg. Qty.	Std. Ctn. Qty.
TMB130-X	Mounting Brackets. T130 Raceway is snapped onto brackets. Can be used as required anywhere along the raceway.	Black	10	100
TWR130-X	Wire Retainer. Holds wires in place during installation.	Gray	10	100

PAN-WAY® Pre-Cut Cover and Type T Outlet Box

- For mounting standard NEMA faceplates
- Cover length = 7.05" (179mm)

- Cutout dimension = 2.42" x 4.06" (61.5mm x 103mm)



TB5583-V



TBSR-Q



T130G

Part Number	Part Description	Color‡	Std. Pkg. Qty.	Std. Ctn. Qty.
TB5583-V	Outlet Box. Used for mounting single gang NEMA standard electrical devices and faceplates.	Gray	5	60
TBSR-Q	Strain Relief. Required to support cable connections in vertically mounted raceway applications. Snaps onto TB5583-V.	Gray	25	—
T130GIW	Pre-cut Cover. Accepts standard NEMA electrical faceplates.	Off White	1	10

‡ For other colors replace IW (Off White) with EI (Electric Ivory) or IG (International Gray).

PAN-WAY® Pre-Cut Covers for Snap-On Modular Furniture Faceplates

- Snap-on Faceplate Pre-Cut Covers are for use with Snap-on Modular Furniture Faceplates
- Cover couplers (located under Type T Raceway fittings) are required for each faceplate

- Cutout dimensions: 2.67" to 2.75" (60.1mm to 72.4mm) x 1.345" to 1.405" (34.2mm to 35.7mm)



T130K1



T130K2

Part Number	Part Description	Color‡	Std. Pkg. Qty.	Std. Ctn. Qty.
T130K1IW	Pre-cut Cover. Accepts One Snap-on Modular Furniture Faceplate.	Off White	1	10
T130K2IW	Pre-cut Cover. Accepts Two Snap-on Modular Furniture Faceplates.	Off White	1	10

‡ For other colors replace IW (Off White) with EI (Electric Ivory) or IG (International Gray).

T130 Hanging Device Brackets



T130DB-X



T130DBD-X



T130DBD installed in Type T raceway



T130DBV

Part Number	Part Description	Color	Std. Pkg. Qty.	Std. Ctn. Qty.
T130DB-X	Single Position Device Bracket. Used to mount NEMA standard electrical receptacles and standard communication module frames (including GFCI).	Gray	10	100
T130DBD-X	Gangable Device Brackets. Can be interlocked to mount NEMA standard electrical receptacles (including GFCI) and standard communication module frames.	Gray	10	100
T130DBV	Single Position Vertical Device Bracket. Used to mount NEMA standard electrical receptacles (including GFCI) and standard communication module frames.	White	1	10

T130 Snap-On Faceplates



T130DMC2



T130DMC



T130LMC

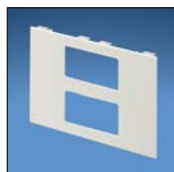

T130RMC2



T130RMC



T130TDMC



T130TMC

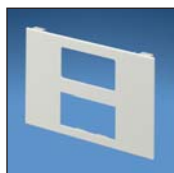

T130TRMC

Part Number	Part Description	Color‡	Std. Pkg. Qty.	Std. Pkg. Qty.
T130DMC2IW	Covers 2 NEMA standard 106 duplex electrical devices or standard communication module frames. Replaces faceplate and pre-cut raceway cover. For use with T130DBD-X and TD68* divider wall.	Off White	1	10
T130DMCIW	Covers NEMA standard 106 duplex electrical devices or standard communication module frames. Replaces faceplate and pre-cut raceway cover.	Off White	1	10
T130LMCIW	Covers NEMA standard twist lock electrical devices or standard communication module frames. Replaces faceplate and pre-cut raceway cover.	Off White	1	10
T130RMC2IW	Covers 2 NEMA standard rectangular electrical devices or standard communication module frames. Replaces faceplate and pre-cut raceway cover. For use with T130DBD-X and TD68* divider wall.	Off White	1	10
T130RMCIW	Covers NEMA standard rectangular electrical devices or standard communication module frames. Replaces faceplate and pre-cut raceway cover.	Off White	1	10
T130TDMCIW	Covers NEMA standard duplex electrical devices or standard communication module frames and provides proper sized opening to accept snap-on modular furniture faceplates.	Off White	1	10
T130TMCIW	Provides proper sized opening to accept snap-on modular furniture faceplates.	Off White	1	10
T130TRMCIW	Covers NEMA standard rectangular electrical devices or standard communication module frames and provides proper sized opening to accept snap-on modular furniture faceplates.	Off White	1	10

‡ For other colors replace IW (Off White) with EI (Electric Ivory) or IG (International Gray).

*Type T divider wall available in 8' and 10' lengths.

Quick Wire Fill Capacities for Type T130 Raceway

This information is to be used as a guide in selecting the proper size raceway. The maximum amounts may vary according to the wire installation methods, straightness of wires, etc.

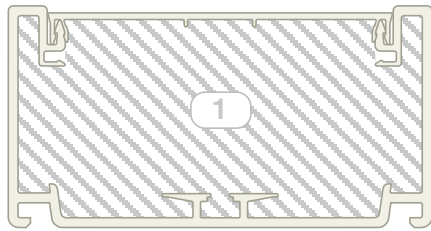

A = 10.96 in²

Wirefill #1: T130 Raceway with no devices.

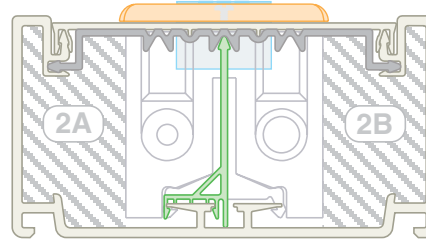

A = 2.56 in²

A = 2.56 in²

Wirefill #2: T130 Raceway — Power and data using T-Box and U.S. Standard “Screw-on” Electrical/Communication Faceplates.

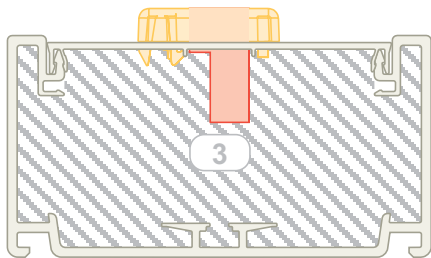

A = 10.34 in²

Wirefill #3: T130 Raceway — Data only using Modular Furniture Faceplates.

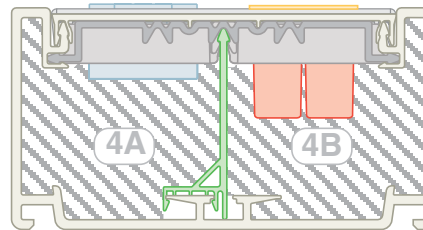

4A = 3.72 in²

4B = 3.52 in²

Wirefill #4: T130 Raceway — Power and data using T130RMC2 Faceplate.

SPEC = 40% wire fill — The recommended design in cable capacity, leaves room for future moves, adds and changes.

MAX for Data = 60% wire fill — The maximum cable quantity based on cable interweaving and packing factors.

MAX for Power wire fill — The maximum of electrical cables based on UL temperature rise test.

Raceway Type & Configuration	Fill Area (in ²)	Electrical Cables			Data Grade Cable	Data Grade Cable	Coax Cable		Fiber Optic Cable			
		14 AWG	12 AWG	10 AWG	24 AWG/UTP CM	24 AWG/UTP CM	RG6		2 Strand			
		THHN/T90			Cat 5e (4pr)	Cat 6 (4pr)	DIA. = .275		DIA. = .175			
		.105	.122	.153	DIA. = .217	DIA. = .250	DIA. = .275		DIA. = .175			
		FILL			FILL	FILL	FILL		FILL			
MAX	MAX	MAX	SPEC	MAX	SPEC	MAX	SPEC	MAX	SPEC	MAX		
(UL Temp Rise Test)			(40%)	(60%)	(40%)	(60%)	(40%)	(60%)	(40%)	(60%)		
1. T130: No devices.	10.96	31	28	26	119	178	89	133	58	87	182	274
2A. T130: Power and data using T-Box and U.S. Standard Faceplate.	2.56	17	15	14	28	42	20	31	14	20	43	64
2B. T130: Power and data using T-Box and U.S. Standard Faceplate.	2.56	—	—	—	28	42	20	31	14	20	43	64
3. T130: Data only using Modular Furniture Faceplate.	10.34	—	—	—	108	162	84	126	55	82	166	249
4A. T130: Power and data using T130RMC2 Faceplate.	3.72	20	16	17	40	60	30	45	20	30	66	99
4B. T130: Power and data using T130RMC2 Faceplate.	3.52	—	—	—	38	57	28	43	19	28	80	120

System Overview

Quick Selection Guide

Office Furniture

Cove

TG-70

T-70 & Twin-70

T-45

Ultimate ID System

Faceplates, Boxes & Labeling

LD Profile

T130

Outlet Pole

Technical Info

Glossary & Index

PANDUIT®

NON-METALLIC SURFACE RACEWAY

NOTES

PAN-POLE™ ALUMINUM OUTLET POLE

PAN-POLE™ Aluminum Outlet Poles are available in versions for power and communications or communications only. They provide industry leading solutions for cable routing in an open office environment.



- Dual channel aluminum construction provides complete separation of power and data
- Tamper resistant cover
- 1" bend radius protection for data routing above ceiling
- PAN-POLE™ Aluminum Outlet Pole can accept PAN-WAY® Snap-on Faceplates and NEMA standard screw-on faceplates
- Optional bracket allows PANDUIT® screw-on or NEMA standard screw-on communication faceplates to be mounted anywhere along the outlet pole
- Allows for customized placement of data outlets

PANDUIT®

NON-METALLIC SURFACE RACEWAY



PAN-POLE™ Power and Communication Pole

- Dual channel aluminum pole for routing both power and low voltage communication cabling
- UL and CSA rated 600V

- Available in 11' or 13' lengths and supplied with a blank non-metallic cover
- Electrical outlets are pre-wired

Pre-installed components include:

1. Blank non-metallic cover
2. Two 20A factory wired rectangular outlets with wiring fed through power channel to base of power entry box
3. Power entry with 1/2" and 3/4" conduit breakouts
4. Removable plate for power wiring connections
5. Ground screw pre-mounted behind removable plate

Supplied mounting hardware includes:

1. Entry end bend radius fitting
2. Ceiling T-bar bracket
3. Ceiling tile trim plate
4. End cap
5. End cap floor grip pad



PCPA11R20
PCPA13R20

Part Number	Part Description	Color‡	Std. Pkg. Qty.
PCPA11R20IW	PAN-POLE™ Power and Communication Pole Assembly is supplied in 11' length for maximum ceiling height of 10'.	Off White	1
PCPA13R20IW	PAN-POLE™ Power and Communication Pole Assembly is supplied in 13' length for maximum ceiling heights of 12'.	Off White	1

Communication Components sold separately.

‡ For other colors replace IW (Off White) with EI (Electric Ivory).

PAN-POLE™ Communication Pole

- Single channel aluminum pole for routing low voltage communication cabling only
- Poles are available in 11' or 13' lengths and are supplied with a blank non-metallic cover

Supplied mounting hardware includes:

1. Entry end bend radius fitting
2. Ceiling T-bar bracket
3. Ceiling tile trim plate
4. End cap
5. End cap floor grip pad



PCPA11
PCPA13

Part Number	Part Description	Color‡	Std. Pkg. Qty.
PCPA11IW	PAN-POLE™ Communication ONLY Pole Assembly is supplied in 11' length for maximum ceiling height of 10'.	Off White	1
PCPA13IW	PAN-POLE™ Communication ONLY Pole Assembly is supplied in 13' length for maximum ceiling height of 12'.	Off White	1

Communication Components sold separately.

‡ For other colors replace IW (Off White) with EI (Electric Ivory).

PAN-POLE™ Power Pole Extension Kits



PCPAK22
PCPAK16

Part Number	Part Description	Color‡	Std. Pkg. Qty.	Std. Ctn. Qty.
PCPAK22IW	Power Pole Extension Kit. To extend the 11' power pole to 22'. Extension kit includes: Fully assembled 11' power pole with brace/coupler, additional wiring and screws. NOTE: Customer needs to purchase a separate standard 11' power pole to make the required length.	Off White	1	—
PCPAK16IW	Power Pole extension kit. To extend the 13' power pole to 16'. Extension kit includes: Fully assembled 3' power pole with brace/coupler, additional wiring and screws. NOTE: Customer needs to purchase a separate standard 13' power pole to make the required length.	Off White	1	—

‡ For other colors replace IW (Off White) with EI (Electric Ivory).

When purchasing Power Addition Kit with 20A Outlet, use with *PAN-POLE™* part numbers PCPA11R20IW and PCPA13R20IW.

When purchasing Power Addition Kit without Outlet, rectangular power outlet needs to be purchased separately. Use with *PAN-POLE™* part numbers PCPA11R20EI and PCPA13R20EI.

PAN-POLE™ Power Addition Kits and Standard Faceplate Bracket (for Data)

- Power addition kits (UL listed for field installation) provide for the addition of power outlets to the *PANDUIT®* Power and Communication Pole
- Allow for the installation of up to three additional duplex outlets (five outlets max.)
- Outlets may be added to the existing factory wired circuit or one additional circuit may be added

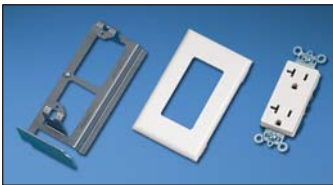

PCPAKR20

Part Number	Part Description	Color‡	Std. Pkg. Qty.	Std. Ctn. Qty.
PCPAKR20IW	Power addition kit includes 20A rectangular outlet with two mounting screws, outlet mounting bracket with one mounting screw and snap-on faceplate.	Off White	1	10
PCPAKRIW	Power addition kit includes outlet mounting bracket with one mounting screw and snap-on faceplate. <i>Rectangular power outlet purchased separately.</i>	Off White	1	10
T70SDB-X	Standard Faceplate Bracket. Used to mount NEMA standard 70mm single gang screw-on electrical/communication faceplates only.	Gray	10	100

‡ For other colors replace IW (Off White) with EI (Electric Ivory).

When purchasing Power Addition Kit with 20A Outlet, use with *PAN-POLE™* part numbers PCPA11R20IW and PCPA13R20IW.

When purchasing Power Addition Kit without Outlet, rectangular power outlet needs to be purchased separately. Use with *PAN-POLE™* part numbers PCPA11R20EI and PCPA13R20EI.

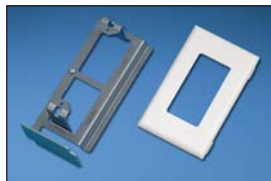

PCPAKR



T70SDB-X

PAN-POLE™ Aluminum Outlet Pole Replacement Parts



PCPKIT



PCPTP



PCPEC



PCPBRC

Part Number	Part Description	Color	Std. Pkg. Qty.	Std. Ctn. Qty.
PCPKITIW	Replacement parts include: Bend radius control ramp, two thumb screws, one 2-piece ceiling trim plate, and one end cap with floor grip pad.	Off White	1	5
PCPTPIW	Replacement ceiling trim plate.	Off White	1	—
PCPECIW	Replacement end cap with floor grip pad. Also available in EI (Electric Ivory)	Off White	1	—
PCPBRC	Replacement bend radius control ramp with T-bar bracket for attaching pole to T-bar. Includes mounting screws.	Gray	1	—

System Overview

Quick Selection Guide

Office Furniture

Cove

TG-70

T-70 & Twin-70

T-45

Ultimate ID System

Faceplates, Boxes & Labeling

LD Profile

T130

Outlet Pole

Technical Info

Glossary & Index

Quick Wire Fill Capacities for PAN-POLE™ Aluminum Outlet Poles

This information is to be used as a guide in selecting the proper size raceway. The maximum amounts may vary according to the wire installation methods, straightness of wires, etc.

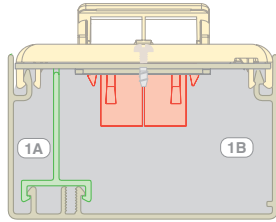

A = .47 in² A = 2.75 in²

Wirefill #1: Power and Communication using Vertical Sloped Snap-on Communication Faceplate.

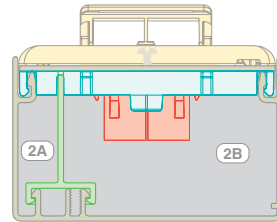

A = .43 in² A = 2.15 in²

Wirefill #2: Power and Communication using Sloped Screw-on Communication Faceplate.

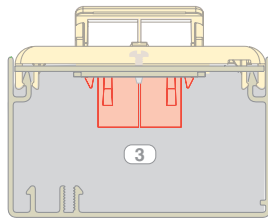

A = 3.47 in²

Wirefill #3: Communication using Vertical Sloped Snap-on Communication Faceplate.

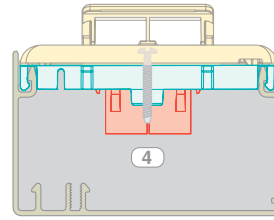

A = 2.83 in²

Wirefill #4: Communication using Sloped Screw-on Communication Faceplate.

SPEC = 40% wire fill — The recommended design in cable capacity, leaves room for future moves, adds, and changes.

MAX for Data = 60% wire fill — The maximum cable quantity based on cable interweaving and packing factors.

MAX for Power wire fill — The maximum of electrical cables based on UL temperature rise test.

Raceway Type & Configuration	Fill Area (in ²)	Electrical Cables			Data Grade Cable		Data Grade Cable		Coax Cable		Fiber Optic Cable	
		14 AWG	12 AWG	10 AWG	24 AWG/UTP CM	24 AWG/UTP CM	RG6		2 Strand			
		THHN/T90			Cat 5e (4pr)		Cat 6 (4pr)		DIA. = .275		DIA. = .175	
		.105	.122	.153	DIA. = .217		DIA. = .250					
		FILL			FILL		FILL		FILL		FILL	
MAX	MAX	MAX	SPEC	MAX	SPEC	MAX	SPEC	MAX	SPEC	MAX	MAX	
(UL Temp Rise Test)			(40%)	(60%)	(40%)	(60%)	(40%)	(60%)	(40%)	(60%)	(40%)	(60%)
1A. Power & Comm: Snap-on Faceplates (Power).	.47	—	11	—	—	—	—	—	—	—	—	—
1B. Communication	2.75	—	—	—	30	45	22	33	15	22	46	69
2A. Power & Comm: Screw-on Faceplates (Power).	.43	—	11	—	—	—	—	—	—	—	—	—
2B. Communication	2.15	—	—	—	23	35	17	26	11	17	36	54
3. Comm Only: Snap-on Faceplates.	3.47	—	—	—	38	57	28	42	18	28	58	87
4. Comm Only: Screw-on Faceplates.	2.83	—	—	—	31	46	23	34	15	22	48	72

Technical Information

TIA/EIA-568-B Commercial Building Telecommunications Cabling Standard	N1
TIA/EIA-569-B Commercial Building Standard for Telecommunications Pathways and Spaces	N1-N2
TIA/EIA-606-A Administration Standard for Commercial Telecommunications Infrastructure	N3
ISO 9001 and ISO 14001	N4
Mounting Guidelines	N4
Flammability	N4
Physical Properties	N5
Raceway Typical Specifications	N6-N8
UL-CSA Performance Requirements	N9
UL-5C Performance Requirements	N10
NEC Article 388 (2002) Brief Explanation	N11

The information contained within this section contains portions of the TIA/EIA-568-B, TIA/EIA-569-B and TIA/EIA-606-A standards published by the Telecommunications Industry Association (TIA). For further information on how to obtain TIA standards please go to <http://global.ihs.com> or contact Global Engineering Documents at 1-800-854-7179 or 303-397-7956.

TIA/EIA-568-B Commercial Building Telecommunications Cabling Standard

Purpose

This standard specifies a generic telecommunications cabling system for commercial building that will support a multi-product, multi-vendor environment. The purpose of this standard is to enable the planning and installation of a structured cabling system for commercial buildings. This standard establishes performance and technical criteria for various cabling system configurations for accessing and connecting their respective elements. When applying specific applications to these cabling systems, the user is cautioned to consult application standards, regulations, equipment vendors, and system and service suppliers for applicability, limitations, and ancillary requirements.

TIA/EIA-569-B Commercial Building Standard for Telecommunications Pathways and Spaces

Purpose

This standard specifies the design and construction practices in support of telecommunications media and equipment. Standards are given for spaces and pathways into and through which telecommunications equipment and media are installed within and between commercial buildings.

General Guidelines

- Perimeter raceways are often installed at baseboard, chair-rail, or ceiling height and may contain work area outlets. When outlets are provided, the outlet height must comply with ADA requirements where applicable.
- Surface raceway may be used as a distribution system and between rooms. The raceway may extend from building pathways to furniture pathways to connect furniture partitions of furniture systems.
- Surface raceway consists of base, cover, and related fittings that mount directly on walls at appropriate work levels to provide a continuous perimeter pathway. Telecommunication outlets are located along the raceway and may be moved or added after initial installation if desired.
- Multi-channel raceway provides a separate perimeter pathway for different cable systems. Separate channels are maintained for each cable system throughout the routing scheme by a divider-wall, either pre-configured or modular.

Separation between Telecommunications and Power Cables

Co-installation of telecommunication cable and power cable is governed by the applicable electrical code for safety. Recommended separation examples of electrically conductive telecommunications cable from branch circuits are as follows:

- Separation from power connectors
- Separation and barriers within raceways
- Separation within outlet boxes or compartments

(Articles 388.70 and 800-52 of the 2002 NEC require a physical barrier between power and telecommunication cables.)

Bend Radius Control

Surface raceway shall incorporate a bend radius of not less than 1-inch under a condition of maximum fill.

Pathway Sizing

For planning perimeter pathways the specification fill shall be 40 percent. A maximum fill of 60 percent is allowed to accommodate unplanned additions after initial installation. The practical raceway capacity for telecommunication cabling will deviate depending on the cable-bending radius. The fill capacities of surface raceways may approach 60% with appropriate bend radius provided. Factors that affect fill capacity (raceway usable area, fittings, terminations, etc.) are discussed below:

Initially one may think... $\frac{\text{RACEWAY AREA}}{\text{CABLE(S) AREA}} = \# \text{ of Cables that fit in the Channels}$ **But in reality this is impossible...Why?**

Consider this...

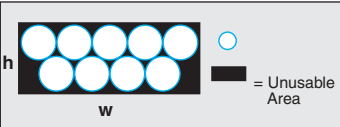

- Cable placed into the channel leave some unusable area depending on the diameter of the cable and shape of the raceway channel. Commonly referred to as the "packing factor"

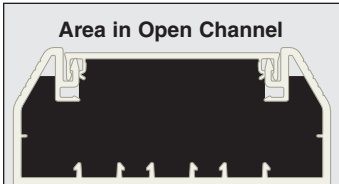

- Termination devices placed within the surface raceway also reduce the available internal area within the channel

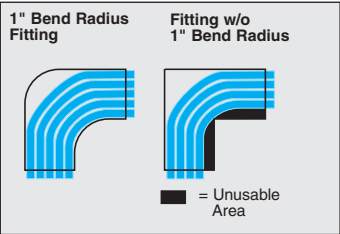

- If the cables being routed require 1" bend radius and the fittings have a smaller radius even less internal area is available for cables

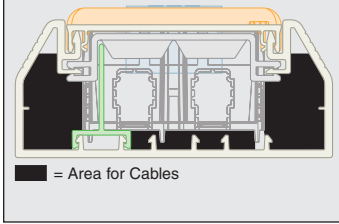

- Add in other real world considerations, such as interwoven/crossed cables and the usable area becomes even less

The following guidelines can be used to provide cable fill quantities when specifying *PAN-WAY®* Surface Raceway Systems.

$\text{SPEC} = \frac{\text{Raceway Internal Area}}{\text{Cable Area}} \times 40\%$	<p>SPEC: The cable quantity to be used when specifying a new raceway. This quantity leaves room for adding cabling in the future.</p>
$\text{MAX} = \frac{\text{Raceway Internal Area}}{\text{Cable Area}} \times 60\%$	<p>MAX: The maximum cable quantity that will fit into the raceway (considering factors previously mentioned).[^]</p>

[^] If the bend radius of the cable cannot be realized with the fittings of the system this value cannot be attained.

Example: Find the SPEC and MAX cable quantities for LDP3 (internal area = .21 in²) when routing Category 5e UTP cabling (dia = .217")

<p>1. Determine Cable Area</p> <p>CABLE AREA</p> <p>= π (r²)</p> <p>= (3.14) (.217/2)²</p> <p>= .037 in²</p>	<p>2. Determine SPEC Quantity</p> <p>SPEC</p> <p>= .21 in² / .037 in² x .40</p> <p>= 2.27 or</p> <p>= 2 cables</p>	<p>3. Determine MAX Quantity</p> <p>MAX</p> <p>= .21 in² / .037 in² x .60</p> <p>= 3.40 or</p> <p>= 3 cables</p>
---	---	---

NOTE 1: New installations of perimeter raceway systems should be sized using a cable fill based on 40% of the raceway usable internal cross-sectional area. A maximum cable fill approaching 60% of the raceway usable cross-sectional area may be attained with the appropriate bend radius for the radius of the cable being routed.

NOTE 2: Power cable fill capacities of non-metallic surface raceways are determined by the UL5A temperature test. The published power wire fill capacity tables indicate the maximum number of power conductors that can be placed into the raceway channel or indicated configuration.

PANDUIT® Quick Wire Fill Capacities reference only the usable area for each system configuration. NOTE: The information provided above is intended for use only as a guideline. Please refer to the specified document for detailed descriptions or standards information.

TIA/EIA-606-A Administration Standard for Commercial Telecommunications Infrastructure

Purpose

The TIA/EIA-606-A standard establishes guidelines for owners, end users, manufacturers, consultants, contractors, designers, installers and facilities administrators involved in the administration of the telecommunications infrastructure. This standard includes requirements for identifiers, records, and **labeling**.

Classes of Administration

Four classes of administration are specified in the standard to accommodate the varying degrees of complexity present in telecommunications infrastructures. The specifications for each class include requirements for identifiers, records, and labeling.

Identifiers An identifier is a unique designation used to refer to each element of the infrastructure

Records A collection of detailed information related to a specific element of the telecommunications infrastructure

Labeling A label is a physical representative of an identifier that is attached to the element identified. The size, color, and contract of all labels should be selected to endure that the identifiers are easily read. Labels should be visible during the installation of and normal maintenance of the infrastructure. Labels should be resistant to the environmental conditions at the point of installation (such as moisture or heat), and should have a design life equal to or greater than that of the labeled component. **To maximize legibility, all labels shall be printed or generated by a mechanical device.**

Class 1 addresses the needs of a premises that is served by a single equipment room (ER). This equipment room is the only telecommunications space (TS) administered.

Required in Class 1 administration are identifiers for the TS, each telecommunications rounding busbar (TSB), the telecommunications main grounding busbar (TMGB), and all elements of the horizontal links (**Patch Panel Ports, IDC (Punch Down Block) Connectors, Copper Four-Pair Horizontal Cable, Fiber Cable, Outlets and other Connectors**).

Class 2 provides for the needs of a single building with one or more telecommunications spaces. Required in Class 2 administration are all identifier required in Class 1 plus building backbone cable identifier, building backbone pair of optical fiber identifier, and firestopping location identifier.

Class 3 addresses the needs of a campus, including its buildings, and outside plant elements. Required in Class 3 administration are all identifiers required in Class 1 and 2 plus identifiers, campus backbone identifiers, campus backbone pair or optical fiber identifiers.

Class 4 addresses the needs of a multi-site system. Required in Class 4 administration are all identifiers required in Class 1, 2 and 3 plus campus or site identifier.

Outlets



In the work area, each individual telecommunications outlet/connector shall be labeled with the horizontal link identifier. The labeling shall appear on the connector, faceplate, or multi-user telecommunications outlet assembly (MUTOA), in a way that clearly identifies the individual connector associated with the particular identifier. A horizontal link identifier shall have a format of **fs-an** where:

f = numeric character(s) identifying the floor of the building occupied by the TS

s = alpha character(s) uniquely identifying the TS on floor, f, or the building area in which the space is located

a = one to two alpha characters uniquely identifying a single patch panel, a group of patch panels with sequentially numbered ports, an IDC connector, or a group of IDC connectors, serving as part of the horizontal cross-connect

n = two to four numeric characters designating the port on a patch panel in the TS

EXAMPLE: 1A-BO7 = origination point first floor, closet A, rack B, position 07

ISO 9001 and ISO 14001

PANDUIT® Raceway Systems Division is registered to both ISO 9001 and ISO 14001 standards.

ISO 9001

ISO 9001 is a voluntary international conformance standard for quality management systems worldwide. It focuses on the overall effectiveness of the quality management system in meeting customer requirements. This recognition indicates that we meet the most comprehensive international standards in design, purchasing, manufacturing, testing, documentation, shipping and service.

ISO 14001

ISO 14001 is a voluntary international conformance standard for environmental systems worldwide. The overall aim of this standard is to support environmental protection and prevention of pollution in balance with the socioeconomic needs. This recognition provides a benchmark to gauge our efforts and to formally communicate to our business partners about our commitment to continual improvement in environmental performance.

Mounting Guidelines**Low Voltage (Data) Installations**

Data only raceway can be mounted with the factory adhesive backing for installation. The mounting surface must be smooth and clean for the adhesive to bond properly.

Caution — Adhesive attachment is permanent! Removal may cause damage to mounting surface (i.e. may remove paper from drywall etc.).

Power Installations

Power rated raceway must be securely fastened to the mounting surface as required by the NEC. UL requires the mounting means to be appropriate for the mounting surface; meaning use a masonry fastener for attaching to brick; a wood screw for attaching to studs, etc.

Flammability

This test method measures the comparative burning characteristics of solid plastic materials.†

UL Vertical Burning Test

Test samples measure 125mm by 13mm by the minimum thickness of the end product. Tests are conducted utilizing non-aged samples (as manufactured) and aged samples (7 days @ 70°C, 158° F.) A standard test flame is applied for two 10 second applications to the unsupported end of a vertically clamped sample. The afterflame time is recorded following the first flame application. Both afterflame and afterglow times are recorded following the second flame application. Also observed and documented is if the sample drips flaming particles that ignite the cotton layer below.

Materials Classed 94V-0 (Criteria)

- Afterflame for each sample does not exceed 10 seconds following the removal of each flame application
- Total afterflame time for a set of five samples following both flame applications is not greater than 50 seconds
- Afterflame plus afterglow time for each sample does not exceed 30 seconds following the second flame application
- A sample does not exhibit afterflame or afterglow up to the holding clamp
- The cotton blanket below the sample does not ignite from flaming particles or droplets from the test sample

† This test is conducted under controlled laboratory conditions. It does not represent the material response under actual fire conditions.

Physical Properties

PROPERTIES	UNITS	TEST METHOD	PVC	ABS	POLY-STRENE	POLYCARB
GENERAL						
Specific Gravity	g/cc	ASTM D 792	1.38	1.08	1.04	1.2
Heat Deflection Temperature @ 264 psi	°F	ASTM D 648	163	160	185	270
Thermal Expansion	10 ⁻⁵ in/in/°F	ASTM D 696	3.7	—	—	—
Thermal Conductivity	Btu/h/ft°F	ASTM C 177	1.3	—	—	—
BURNING CHARACTERISTICS						
Flammability Class	—	UL94	V-0	V-0	V-0	V-0
Smoke Density	—	ASTM E 662	538	—	—	120
Limited Oxygen Index (LOI)	%	ASTM D 2863	40-49	—	—	37.8
HARDNESS						
Durometer	“D”	ASTM D 2240	78	—	—	—
Rockwell	“R”	ASTM D 785	111	—	—	118
TENSILE						
Strength	psi	ASTM D 638	6,200	5,800	4,000	9,000
Modulus	psi	ASTM D 638	390,000	300,000	N/A	N/A
FLEXURAL						
Strength	psi	ASTM D 790	11,200	9,500	4,700	13,200
Modulus	psi	ASTM D 790	350,000	300,000	280,000	325,000
IMPACT STRENGTH						
Notched Izod (.125°) at:		ASTM D 256				
23°C (73°F)	ft-lb/in		17.0	3.0	1.7	12.0
0°C (32°F)	ft-lb/in		1.6	—	—	—
-18°C (0°F)	ft-lb/in		1.1	—	—	—
ELECTRICAL PROPERTIES						
Power Factor:		ASTM D 150				
60 Hz @ 30°C (86°F)	—		2.90	—	—	—
1 MHz @ 30°C (86°F)	—		4.00	—	—	—
Dielectric Constant:		ASTM D 150				
60 Hz @ 30°C (86°F)	—		3.90	—	—	3.01
1 MHz @ 30°C (86°F)	—		3.90	—	—	2.96
Dielectric Strength:		ASTM D 149				
Unconditioned	volts/mil		690	—	—	425
Conditioned	volts/mil		700	—	—	—

NOTE: To the best of our knowledge the above information is accurate, is based upon accepted technical practices and is believed to be reliable. PANDUIT® assumes no liability for the accuracy or completeness of this information.

System Overview

Quick Selection Guide

Office Furniture

Cove

TG-70

T-70 & Twin-70

T-45

Ultimate ID System

Faceplates, Boxes & Labeling

LD Profile

T130

Outlet Pole

Technical Info

Glossary & Index

Raceway Typical Specifications

PAN-WAY® Office Furniture Raceway

OFR non-metallic single channel, one-piece design, adhesive backed, hinged cover surface raceway, shall be used to route, protect, and conceal low voltage, data, voice, and video cabling along the top of modular office furniture partitions. A full complement of fittings with a 1" minimum bend radius compliant with TIA/EIA-568-B must be available. The full complement of fittings will consist of, but not limited to: wall entrance fittings and communication poles for getting cabling into raceway, elbows (internal and external), cross fittings, couplings for joining raceway sections, blank end fittings for closing open ends of the raceway, vertical raceway to join horizontal raceway and desk mounted boxes that will accept either screw-on or "snap-on" faceplates, and corner raceways capable of accepting either screw-on or "snap-on" faceplates. OFR will be manufactured in six-foot lengths from impact resistant material with flammability rating of V-0. OFR finish shall be pure color and will resist scratches and dents and will not peel or corrode. OFR shall be available in three standard colors and shall be optimized for use with the *PANDUIT® PAN-NET®* Communication System.

PAN-WAY® Cove Raceway

WCM35 non-metallic multi-channel capable surface raceway shall be used to route, protect, and conceal data, voice, video, fiber optic and power cabling. The raceway shall be listed as suitable for use in applications up to 600 volts between conductors by Underwriters Laboratories, Inc. per standard 5A, and by Canadian Standards Association, Inc. per 22.2 no. 62.1-03, when screw secured and installed per instructions. A full complement of fittings with a 1" minimum bend radius compliant with TIA/EIA-568-B, must be available. Divider walls must be available to form separate channels in the multi-channel raceway. WCM35 raceway will be manufactured from impact-resistant material with flammability rating of V-0. WCM35 raceway must be tamper resistant yet also allow access for moves, adds and changes. WCM35 raceway finish shall be pure color and will resist scratches and dents and will not peel or corrode. WCM35 Raceway shall be available in off-white as a standard color, shall be paintable, and shall be optimized for use with the *PANDUIT® PAN-NET®* Communication System.

PAN-WAY® TG-70 Surface Raceway

TG non-metallic multi-channel surface raceway shall be used to route, protect, and conceal data, voice, video, fiber optic and power cabling. The raceway shall be listed as suitable for use in applications up to 600 volts between conductors by Underwriters Laboratories, Inc. per standard 5A, and by Canadian Standards Association, Inc. per 22.2 no. 62.1-03, when screw secured and installed per instructions. A full complement of fittings with a 40mm (1.6") minimum bend radius compliant with TIA/EIA-568-B must be available as well as device brackets and internal junction boxes to install a variety of communication and electrical devices. Divider walls must be available to form separate channels in the multi-channel raceway. *PANDUIT®* "snap-on" faceplates for data and power terminations shall be available. TG raceway will be manufactured from impact-resistant material with flammability rating of V-0. TG raceway must be tamper resistant, yet allow access for moves, adds, and changes. TG raceway finish shall be pure color and will resist scratches and dents and will not peel or corrode. TG raceway shall be available in two standard colors and shall be optimized for use with the *PANDUIT® PAN-NET®* Communication System.

PAN-WAY® T-70 Surface Raceway

T-70 non-metallic multi-channel capable surface raceway shall be used to route, protect, and conceal data, voice, video, fiber optic and power cabling. The raceway shall be listed as suitable for use in applications up to 600 volts between conductors by Underwriters Laboratories, Inc. per standard 5A, and by Canadian Standards Association, Inc. per 22.2 no. 62.1-03, when screw secured and installed per instructions. A full complement of fittings with a 1" minimum bend radius compliant with TIA/EIA-568-B, must be available as well as device brackets and internal junction boxes to install a variety of communication and electrical devices. Divider walls must be available to form separate channels in the multi-channel raceway. "Snap-on" faceplates for data and power terminations shall be available. An offset box shall be available, with versions for *PANDUIT®* "snap-on" as well as "screw mount" faceplates, for mounting the power receptacle outside of the raceway channel. T-70 raceway will be manufactured from impact-resistant material with flammability rating of V-0. T-70 raceway must be tamper resistant yet, also allow access for moves, adds and changes. T-70 raceway finish shall be pure color and will resist scratches and dents and will not peel or corrode. T-70 raceway shall be available in three standard colors and shall be optimized for use with the *PANDUIT® PAN-NET®* Communication System.

PAN-WAY® Twin-70 Surface Raceway

Twin-70 non-metallic, multi-channel surface raceway shall be used to route, protect, and conceal data, voice, fiber optic, and power cabling. The raceway shall be listed as suitable for use in applications up to 600 volts between conductors by Underwriters Laboratories, Inc. per standard 5A, and by Canadian Standards Association, Inc. per 22.2 no. 62.1-03, when screw secured and installed per instructions. A full complement of fittings with a 1" minimum bend radius compliant with TIA/EIA-568-B, must be available as well as device brackets and internal junction boxes to install a variety of communication and electrical devices. The raceway shall provide two separate covers to maintain total separation of power and low voltage cabling. PANDUIT® "snap-on" faceplates for data and power terminations shall be available. Twin-70 raceway must be tamper resistant yet also allow access for moves, adds, and changes. Twin-70 shall be manufactured from impact-resistant material with flammability rating of V-0. Twin-70 raceway finish shall be pure of color and will resist scratches and dents, and will not peel or corrode. Twin-70 raceway shall be available in three standard colors and shall be optimized for use with the PANDUIT® PAN-NET® Communication System.

PAN-WAY® T-45 Surface Raceway

T-45 non-metallic multi-channel, two-piece, hinged cover design surface raceway shall be used to route, protect, and conceal data, voice, video, fiber optic and power cabling. The raceway shall be listed as suitable for use in applications up to 600 volts between conductors by Underwriters Laboratories, Inc. per standard 5A, and by Canadian Standards Association, Inc. per 22.2 no. 62.1-03, when screw secured and installed per instructions. A full complement of fittings with a 1" minimum bend radius compliant with TIA/EIA-568-B, must be available as well as device brackets and junction boxes to install a variety of communication and electrical devices. Divider walls must be available to form separate channels in the multi-channel raceway. An offset box shall be available, with versions for "snap-on" as well as "screw mount" faceplates, for mounting the power receptacle or the data receptacles outside of the raceway channel. T-45 raceway will be manufactured from impact-resistant material with flammability rating of V-0. T-45 raceway must be tamper resistant yet also allow access for moves, adds and changes. T-45 raceway finish shall be pure color and will resist scratches and dents and will not peel or corrode. T-45 raceway shall be available in two standard colors and shall be optimized for use with the PANDUIT® PAN-NET® Communication System.

PAN-WAY® LD2P10 Surface Raceway

LD2P10 non-metallic, two channel, one-piece tamper resistant latch design, adhesive backed, hinged cover, surface raceway shall be used to route, protect, and conceal data, voice, fiber optic, and power cabling. The raceway shall be listed as suitable for use in applications up to 600 volts between conductors by Underwriters Laboratories, Inc. per standard 5A, and by Canadian Standards Association, Inc. per 22.2 no. 62.1-03, when screw secured and installed per instructions. The raceway will include a full complement of fittings, which maintain a 1" minimum bend radius, compliant with TIA/EIA-568-B, as well as junction boxes, which allow termination of both power and communications cabling. LD2P10 raceway will be manufactured from impact-resistant material with flammability rating of V-0. LD2P10 raceway finish shall be pure color and will resist scratches and dents, and will not peel or corrode. LD2P10 raceway shall be available in four standard colors, and shall be optimized for use with the PANDUIT® PAN-NET® Communication System.

PAN-WAY® LDP Surface Raceway

LDP non-metallic single channel, one-piece tamper resistant latch design, adhesive backed, hinged cover, surface raceway, shall be used to route, protect and conceal data, voice, video, fiber optic or power cabling. The raceway shall be listed as suitable for use in applications up to 600 volts between conductors by Underwriters Laboratories, Inc. per standard 5A, when screw secured and installed per instructions. The raceway will include a full complement of power, bend radius control (BRC), and standard fittings consisting of, but not limited to: elbows (internal and external), couplings for joining raceway sections, blank end fittings for closing open ends of the raceway, entrance fittings, reducer fittings, tee fittings, and an optional raceway installation tool. The BRC fittings shall incorporate a minimum 1" bend radius as recommended for Category 5e & 6 UTP and fiber optic cabling in TIA/EIA-568-B. LDP surface raceway will be manufactured in two different lengths from impact-resistant material with flammability rating of V-0. LDP raceway finish shall be pure color and will resist scratches and dents and will not peel or corrode. LDP raceway shall be available in three sizes, four standard colors and shall be optimized for use with the PANDUIT® PAN-NET® Communication System.

PAN-WAY® LD Surface Raceway

LD non-metallic single channel, one-piece design, adhesive backed, hinged cover surface raceway, shall be used to route, protect, and conceal low voltage data, voice, and video cabling. The raceway will include a full complement of bend radius control (BRC) and standard fittings consisting of, but not limited to: elbows (internal and external), couplings for joining raceway sections, blank end fittings for closing open ends of the raceway, entrance end fittings, reducer fittings, and tee fittings. The BRC fittings shall incorporate a minimum 1" bend radius as recommended for Category 5e & 6 UTP and fiber optic cables, in TIA/EIA-568-B. LD raceway will be manufactured in 2 different lengths from impact resistant material with flammability rating of V-0. LD raceway finish shall be pure color and will resist scratches and dents and will not peel or corrode. LD raceway shall be available in three sizes and four standard colors and shall be optimized for use with the *PANDUIT® PAN-NET®* Communication System.

PAN-WAY® LDS Surface Raceway

LDS non-metallic surface raceway will be a one piece, solid raceway used to route, protect, and conceal data network, voice or power cabling. The raceway shall be listed as suitable for use in applications having up to 600 volts between conductors by Underwriters Laboratories, Inc. per standard 5A when screw secured with mounting straps and per installation instructions. The raceway shall be manufactured from impact resistant material with flammability rating of UL94V-0. A full complement of power, 1" bend radius control (BRC), and standard snap-on fittings must be available. All fittings and boxes shall be tamper resistant to prevent unauthorized access to cables. LDS raceway finish shall be pure color and will resist scratches and dents and will not peel or corrode. It shall be optimized for use with the *PANDUIT® PAN-NET®* Communication System.

PAN-WAY® Type T130 Surface Raceway

T130 non-metallic multi-channel surface raceway shall be used to route, protect, and conceal power and/or communications cabling. The raceway shall be listed as suitable for use in applications up to 600 volts between conductors by Underwriters Laboratories, Inc. per standard 5A, and by Canadian Standards Association, Inc. per 22.2 no. 62.01-03, when screw secured and installed per instructions. A full complement of power rated fittings must be available as well as device brackets to install a variety of communication and electrical devices. Divider wall must be available to form separate channels in the multi-channel raceway. T130 raceway must be tamper resistant yet also allow access for moves, adds, and changes and must be manufactured from impact resistant material with a flammability rating of V-0. T130 raceway finish shall be pure color and will resist scratches and dents and will not peel or corrode. T130 raceway mounting brackets shall be available to mount to irregular mounting surfaces. T130 raceway shall be available in three standard colors and shall be optimized for use with the *PANDUIT® PAN-NET®* Communication System.

PAN-WAY® PAN-POLE™ Aluminum Outlet Poles for Power and Communication

The Aluminum Outlet Poles shall be an aluminum channel with a cross sectional area of 2.90" x 1.77", available in 11 or 13 foot lengths in two standard colors. The Power and Communication Pole shall consist of two compartments and be UL-5 listed and CSA certified to 600V. The pole shall be supplied with a power entry box with ½ conduit breakouts and 8" removable plate. One compartment shall be factory wired with two duplex style 20A, 125V NEMA 5-2OR grounding-type specification grade receptacles and the second compartment left blank for field installation of telephone, data network or other low voltage cabling. The Communications Only Pole shall consist of one compartment for field installation of telephone, data network or other low voltage cabling. Both pole versions shall be capable of accepting 70mm snap-on faceplates as well as NEMA standard screw mount faceplates and be provided with a non-metallic 70mm (2.75") cover, 1" bend radius entry fitting and t-bar mounting bracket, ceiling trim plates and floor end cap with grip pad.



NON-METALLIC SURFACE RACEWAY



UL-CSA Performance Requirements



(Standard for Safety of Non-Metallic Surface Raceways and Fittings)

The UL and CSA marks found on *PANDUIT*® non-metallic surface raceway systems assures that the raceway components have been evaluated in accordance with the UL 5A/CSA 22.2 No. 62.1-03 standards. Our systems meet or exceed the requirements of **ALL** (not just some) of the tests outlined. This assures the end user of a quality product which will perform in a safe manner when installed as recommended.

A product bearing UL/CSA complies with the following:

- Utilizes a UL RECOGNIZED material, which meets specific product property requirements, such as volume resistivity, hot wire ignition, high current arc ignition, dielectric strength and heat deflection temperature.
- FLAMMABILITY: The system materials have a flammability rating of V-0. The finished part complies with flammability rating of 5VA. Both the raceway and associated fittings exhibit self-extinguishing characteristics.
- LOW TEMPERATURE HANDLING AT -34°C: This test assures that the raceway integrity will remain intact under typical conditions encountered during shipment and handling in a hostile subzero temperature.
- COLD TEMPERATURE IMPACT AT 0°C: A 1.18lb steel sphere is dropped from a height of 51 inches to produce an impact of 5 ft.-lbs. This test simulates the impact resistance of the product when subjected to a cold temperature extreme following installation, such as cold storage or an area without heat.
- CRUSH: Both raceway and fittings are subjected to a compressive load of 300 lbs., which is maintained for one minute. This load is twice the weight of an average person. Following the removal of the load, both the raceway and fittings must remain intact and show an acceptable level of permanent deformation.
- MOLD STRESS: During the cooling process, stresses may be frozen in the raceway or fitting. This test conditions the product in an air-circulating oven for seven (7) hours at the maximum intended useful temperature of the system. After cooling to room temperature the raceway system with cover must remain intact and secure.
- TEMPERATURE TEST: The raceway undergoes a several hour test to determine the maximum number of electrical conductors to operate the system. This assures the end use that the power conductors and raceway will not exceed their respective temperature rating during their intended operation.
- TRIAL INSTALLATION: This is conducted to verify that the recommended installation instructions and mounting hardware are effective and that the system maintains a complete and safe enclosure of conductors.
- RECEPTACLE SECURENESS: Assures that a receptacle shall remain secure in the raceway when a power cord attachment plug is inserted and a 25 lb. weight is applied for 60 seconds. This test is conducted with the receptacle positioned horizontally to the ground and then repeated with receptacle face at a 30° angle to the power cord.
- SECURITY OF KNOCKOUT AND BREAKAWAY TAB: A knockout or breakaway tab shall remain intact following a force application of 10 lbs. for 60 seconds. Following the removal of a tab, no sharp edges shall be left which could cause abrasion of the conductor insulation. This test assures that the tab can resist an applied force but can be removed easily per recommended instructions.
- HINGE CYCLING: A section of hinged raceway is mounted per instruction sheet. The raceway is then opened 90 degrees from its initial position and closed, without latching for 100 cycles. The hinge shall have no functional damage. This assures a safe lifetime of intended use.

NOTE: The information provided above is intended for use only as a guideline. Please refer to the specified document for detailed test descriptions or standards information.

System Overview

Quick Selection Guide

Office Furniture

Cove

TG-70

T-70 & Twin-70

T-45

Ultimate ID System

Faceplates, Boxes & Labeling

LD Profile

T130

Outlet Pole

Technical Info

Glossary & Index



UL 5C Performance Requirements

(Standard for Surface Raceways and Fittings for use with Data Signal and Control)

The marks found on *PANDUIT*[®] non-metallic surface raceway systems assures that the raceway components have been evaluated in accordance with the UL 5C standard. Our systems meet or exceed the requirements of ALL (not just some) of the tests outlined. This assures the end user of a quality product, which will perform in a safe manner when installed as recommended.

A product bearing UL 5C complies with the following:

- Utilizes a UL RECOGNIZED material with specific properties such as heat deflection temperature and flame class rating.
- FLAMMABILITY: The system materials have flammability rating of V-0. Both the raceway and associated fittings exhibit self-extinguishing characteristics.
- IMPACT AT 23°C: A 1.18lb steel sphere is dropped from a height of 51 inches to product an impact of 5 ft.-lbs. This test simulates the impact resistance of the product.
- CRUSH: Both raceway and fittings are subjected to a compressive load of 100 lbs., which is maintained for one minute. Following the removal of the load, both the raceway and fittings must remain intact.
- MOLD STRESS: During the cooling process, stresses may be frozen in the raceway or fitting. This test conditions the product in an air-circulating oven for seven (7) hours at 70°C. After cooling to room temperature the raceway system with cover must remain intact and secure.
- TRIAL INSTALLATION: This is conducted to verify that the recommended installation instructions and mounting hardware are effective and that the system maintains a complete and safe enclosure of conductors.
- SECURITY OF KNOCKOUT AND BREAKAWAY TABS: A knockout or breakaway tab shall remain intact following a force application of 10 lbs. for 60 seconds. Following the removal of a tab, no sharp edges shall be left which could cause abrasion of the conductor insulation. This test assures that the tab can resist an applied force but can be removed easily per recommended instructions.
- HINGE CYCLING: A one foot length of raceway is mounted per instruction sheet. The raceway is then opened 90 degrees from its initial position and closed without latched for 20 cycles. The hinge shall have no functional damage. This assures a safe lifetime of intended use.

NOTE: The information provided above is intended for use only as a guideline. Please refer to the specified document for detailed test descriptions or standards information.

NEC Article 388 (2002) Brief Explanation (Surface Non-Metallic Raceways)

Surface non-metallic raceways are addressed under section 388 of the National Electric Code. Please reference this section of the NEC for specific information regarding surface non-metallic raceway. 388 applies to a type of surface non-metallic raceway and fittings of suitable non-metallic material that is resistant to moisture and chemical atmospheres. It shall also be flame retardant, resistant to impact and crushing, resistant to distortion from heat under conditions likely to be encountered in service, and resistant to low temperature effects.

Section 388 includes the following:

388.10 Uses Permitted

The use of surface non-metallic raceways shall be permitted in dry location. Surface non-metallic raceways shall be permitted to pass transversely through dry walls, dry partitions, and dry floors if the length passing through is unbroken. Access to the conductors shall be maintained on both sides of the wall, partition, or floor.

388.56 Splices and Taps

Splices and taps shall be permitted in surface non-metallic raceways having cover that is accessible after installation. The conductors, including splices and taps, shall not fill the raceway to more than 75 percent of its area at that point. Splices and taps in surface non-metallic raceways without removable covers shall be made only in junction boxes. All splices and taps shall be made by approved methods.

388.70 Combination Raceways

Where combination surface non-metallic raceways are used both for signaling and for lighting and power circuits, the different systems shall be run in separate compartments, identified by printed legend or by sharply contrasting colors of the interior finish.

388.100 Construction

Surface non-metallic raceways shall be of such construction as will distinguish them from other raceways. Surface non-metallic raceways and their elbows, couplings, and similar fittings shall be so designed that the sections can be mechanically coupled together and installed without subjecting the wires to abrasion.

System
Overview

Quick
Selection
Guide

Office
Furniture

Cove

TG-70

T-70
&
Twin-70

T-45

Ultimate
ID
System

Faceplates,
Boxes &
Labeling

LD Profile

T130

Outlet
Pole

Technical
Info

Glossary
&
Index

PANDUIT[®]

NON-METALLIC SURFACE RACEWAY

NOTES

Index

C061X030FJ6	.C9, J2, J4-J6, J17	JB1DIW-A	.J7
C061X030FJJ	.C9, J2, J4-J6, J17	JB1FSIW-A	.J2
C125X030FJ6	.C9, J2, J4-J6, J17	JB1IW-A	.J7
C125X030FJJ	.C9, J2, J4-J6, J17	JBA-X	.J7
C138X019FJ6	.J17	JBD1	.J8
C138X019FJJ	.J17	JBD2	.J8
C188X030FJ6	.J17	JBP1DIW	.J8
C188X030FJJ	.J17	JBP1EIW	.J8
C195X040Y16	.J17	JBP1IW	.J8
C195X040Y1J	.J17	JBP1I IW	.J8
C252X030FJ6	.J17	JBP1MD20IW	.J9
C252X030FJJ	.J17	JBP1MR20IW	.J9
C261X030FJ6	.J17	JBP2DIW	.J7
C261X030FJJ	.J17	JBP2FSIW	.J2
C261X035Y16	.J17	JBP2IW	.J7
C261X035Y1J	.J17	JBP2SIW	.J8
C282X030Y16	.J17	JBX3510IW-A	.J7
C282X030Y1J	.J17	LD10IW10-A	.K14
C288X040Y16	.J17	LD10IW6-A	.K14
C288X040Y1J	.J17	LD10IW8-A	.K14
C379X030FA6	.J17	LD2P10IW10-A	.K13
C379X030FJJ	.J17	LD2P10IW8-A	.K13
C390X030Y16	.J17	LD3IW10-A	.K14
C390X030Y1J	.J17	LD3IW6-A	.K14
CA3IW-X	.J11	LD3IW8-A	.K14
CA5IW-X	.J11	LD5IW10-A	.K14
CF10IW-X	.K17	LD5IW6-A	.K14
CF3IW-E	.K17	LD5IW8-A	.K14
CF5IW-E	.K17	LDP10IW10-A	.K15
CFX10IW-X	.K13, K18, K19	LDP10IW8-A	.K15
CFX3IW-X	.K18, K19	LDP3IW10-A	.K15
CFX5IW-X	.K18, K19	LDP3IW8-A	.K15
CP106IW	.J10	LDP5IW8-A	.K15
CP106IW-2G	.J10	LDS3IW10-A	.K16
CPGIW	.J10	LDS5IW10-A	.K16
CPGIW-2G	.J10	LDW10-V	.K22
CPNIW	.J10	LDW3-V	.K22
CPNIW-2G	.J10	LDW5-V	.K22
CRFC5IW-X	.K17, K18	LMD3IW-Q	.K16
CRFX5IW-X	.K19	LMD5IW-Q	.K16
DCEFXIW-X	.K18, K19	LS6-ACS	.J14
DCF10IW-X	.K17	LS6-BP	.J14
DCF3IW-X	.K17	LS6-CLN	.J14
DCF5IW-X	.K17	LS6-KIT	.J14
ECF10IW-X	.K17	LS6-PCKIT	.J14
ECF3IW-E	.K17	LS6-RHBLK	.J14
ECF5IW-E	.K17	LS6-RRBLK	.J14
ECFX10IW-X	.K13, K18, K19	LS6-RRWHT	.J14
ECFX3IW-X	.K18, K19	LS6-RWBLK	.J14
ECFX5IW-X	.K18, K19	LS7	.H7, J14
EDU20IW-X	.J11	LS7-25-1	.H7, J17
EEFXIW	.K13	LS7-25-2	.H7, J17
EGU20IW-X	.J11	LS7-38-1	.H7, J17
ERU20IW-X	.J11	LS7-38-2	.H7, J17
ETU20IW-X	.J11	LS7-50-1	.H7, J17
FBA10IW-X	.K17	LS7-50-2	.H7, J17
FBA5IW-X	.K17	LS7-75NL-1	.H7, J17
FG1EI50-A	.K21	LS7-75NL-2	.H7, J17
FG1EI6-A	.K21	LS7-ACS	.H7, J14
FG3EI50-A	.K21	LS7-CLN	.H7, J14
FP2DCIW	.J10	NK2HSRFIW	.J4
FP2RCIW	.J10	NK4HSRFIW	.J4
FG3EI6S-A	.K21	NK4VSRFIW	.J4
ICF10IW-X	.K17	OCF10IW-X	.K17
ICF3IW-E	.K17	OCF3IW-E	.K17
ICF5IW-E	.K17	OCF5IW-E	.K17
ICFC10IW-X	.K18	OCFC10IW-X	.K19
ICFC3IW-X	.K18	OCFC3IW-X	.K19
ICFC5IW-X	.K18	OCFC5IW-X	.K19
ICFX10IW-X	.K13, K19	OCFX10IW-X	.K13, K18
ICFX3IW-X	.K19	OCFX3IW-X	.K18
ICFX5IW-X	.K19	OCFX5IW-X	.K18

Index

	OF70FH2OB	.C8	T130DB-X	.L8
	OF70FH4OB	.C8	T130DBD-X	.L8
	OF70FV2OB	.C8	T130DBV	.L8
	OF70FV4OB	.C8	T130DMC2IW	.L8
Office Furniture	OFCR70ECOB	.C7	T130DMCIW	.L8
	OFCR70OB6	.C6	T130GIW	.L7
	OFCRC70OB6	.C6	T130K1IW	.L7
	OFR20CCOB-X	.C8	T130K2IW	.L7
	OFR20CPOB8	.C6	T130LMCIW	.L8
Cove	OFR20CROB	.C8	T130RMC2IW	.L8
	OFR20DMBOB	.C7	T130RMCIW	.L8
	OFR20ECOB	.C8	T130TD	.L6
	OFR20ICOB	.C8	T130TDMCIW	.L8
	OFR20MPTOB	.C7	T130TMCIW	.L8
	OFR20OB6	.C6	T130TRMCIW	.L8
TG-70	OFR20OCOB	.C8	T45BIW10	.G6
	OFR20OFCR70OB1	.C7	T45BIW10-A	.G6
	OFR20OFCR70OB2	.C7	T45BIW8	.G6
	OFR20OFCR70OB4	.C7	T45BIW8-A	.G6
	OFR20RAOB	.C8	T45CCIW-X	.G7
T-70 & Twin-70	OFR20SOOB	.C7	T45CIW10	.G6
	OFR20TOB	.C8	T45CIW8	.G6
	OFR20WEOB	.C7	T45DW10	.G6
	OFVR5OB6	.C6	T45DW8	.G6
	P32W2A2-100-7	.K22	T45ECIW-X	.G7
	P32W2A2-100-72	.K22	T45EEIW-X	.G7
T-45	P32W2A2-50-7	.K22	T45HDBIW-X	.G7
	P32W2A2-50-72	.K22	T45HEBIW	.G7
	P32W2A2-75-7	.K22	T45HEGBIW	.G7
	P32W2A2-75-72	.K22	T45CIW	.G7
	P32W2R1-100-7	.K22	T45OCIW	.G7
	P32W2R1-100-72	.K22	T45RAIW	.G7
Ultimate ID System	P32W2R1-150-72	.K22	T45RLDIW	.G7
	P32W2R1-50-7	.K22	T45TD	.G7
	P32W2R1-50-72	.K22	T45TIW	.G7
	P32W2R1-75-7	.K22	T45TRI	.G7
	P32W2R1-75-72	.K22	T45WC2IW	.G6
Faceplates, Boxes & Labeling	PCPA11IW	.M3	T45WCIW	.G6
	PCPA11R20IW	.M2	T702BCIW-X	.F11
	PCPA13IW	.M3	T702BIW10	.F10
	PCPA13R20IW	.M2	T702BIW8	.F10
	PCPAK16IW	.M4	T702BCIW	.F11
	PCPAK22IW	.M4	T702ECIW	.F11
	PCPAKR20IW	.M4	T702EEIW	.F11
LD Profile	PCPAKRIW	.M4	T702ICIW	.F11
	PCPBRC	.M5	T702OCIW	.F11
	PCPECIW	.M5	T702RAIW	.F11
	PCPKITIW	.M5	T702ECIW	.F11
	PCPTPIW	.M5	T702TIW	.F11
	PFX-0	.H10	T702TRI	.F11
T130	PFX-2	.H10	T702TRIW	.F11
	PROG-EMCD	.J15	T702TRLIW	.F11
	PROG-WIN2CD	.H9, J15	T70B1IW	.J3
	PSJBXIW	.J9	T70B2IW	.J3
	RAEFXIW-X	.K18, K19	T70BH1IW	.J3
	RAF10IW-X	.K17	T70BH2IW	.J3
Outlet Pole	RAF3IW-E	.K17	T70BCIW-X	.F8
	RAF5IW-E	.K17	T70BFI	.F9
	RAFC10IW-X	.K18	T70BFIW	.F9
	RAFC3IW-X	.K18	T70BIW10	.F8
	RAFC5IW-X	.K18	T70BIW8	.F8
	RAFX10IW-X	.K13, K19	T70CCIW-X	.F8, F10
Technical Info	RAFX3IW-X	.K19	T70CIW10	.E6, F8, F10
	RAFX5IW-X	.K19	T70CIW8	.F8
	RF10X3IW-X	.K17	T70DW10	.F8, F10
	RF10X5IW-X	.K17	T70DW8	.F8, F10
	RF5X3IW-E	.K17	T70ECIW	.F9
	RFX103IW-X	.K18, K19	T70EEIW	.F9
	RFX105IW-X	.K18, K19	T70FH2IW	.J2-J10
Glossary & Index	RFX53IW-X	.K18, K19	T70FH4IW	.J2-J10
	RJBX3510IW	.J9	T70FSB	.F12
	SRT	.K21	T70FV2IW	.J2-J10

Index

T70FV4IW	J2-J10	TGRAIW	E7
T70HB-X	F12	TGSICIW	E7
T70HB3-X	F12	TGSOCIW	E7
T70HB3GFCI-X	F12	TGTD	E7
T70ICIW	F8, F9	TGTIW	E7
T70KW2IW	J4	TGTRIW	E7
T70KW4IW	J4	TIC130IW	L6
T70L2IW	J4, J5	TMB130-X	L7
T70L4IW	J4, J5	TOCB130IW	L6
T70LV2IW	J4, J5	TOCC130IW	L6
T70LV4IW	J4, J5	TRA130IR	L6
T70N2IW	J6-J10	TRA130IW	L6
T70N4IW	J6-J10	TT130IW	L6
T70NV2IW	J6-J10	TWR130-X	L7
T70NV4IW	J6-J10	UICFP2IW	H4
T70OCIW	F8, F9	UICFP4IW	H4
T70PGIW	J2-J10	UICFP6IW	H4
T70PGSIW	J2-J10	UICFPH2IW	H4
T70PIW	J2-J10	UICFPH4IW	H4
T70PNIW	J2-J10	UICFPHSE2IW	H3
T70PSIW	J2-J10	UICFPHSE4IW	H3
T70RAIW	F8, F9	UICFPSE2IW	H3
T70S-X	F12	UICFPSE4IW	H3
T70SDB-X	C8, E8, F12, M4	UICFPSE6IW	H3
T70TDB	F9	UICIDIW-C	H10
T70TDC	F9	UICIPW-C	H10
T70TDT	F9	UILC1CL-X	H10
T70TIW	F8	UILC2CL-X	H10
T70TRCIW	F9	UILC3CL-X	H10
T70TRI	F9	UILC4CL-X	H10
T70TRIW	F9	UILC6CL-X	H10
T70WC2IW	F9	UILJ1	H8
T70WCIW	F9	UILJ2	H8
T70WM40TRIW	F9	UILJ3	H8
T70WR-X	F12	UILJ4	H8
TB130IW10	L5	UILJ6	H8
TB130IW8	L5	UILJCOMBO	H8
TB5583-V	L7	UISW	H8, J16
TBSR-Q	L7	UIT70FH2IW	H5
TC130IW10	L5	UIT70FH4IW	H5
TC130IW8	L5	UIT70FV2IW	H5
TCFB3070IW-X	L6	UIT70FV4IW	H5
TCFC130IW-X	L6	UIWOL1-L	H9
TD6810	L5	UIWOL2-L	H9
TD688	L5	UIWOL3-L	H9
TEC130IW	L6	UIWOL4-L	H9
TEE130IW	L6	UIWOL6-L	H9
TF10IW-X	K17	WCM35BFIW	D7
TF3IW-E	K17	WCM35BIW8	D6
TF5IW-E	K17	WCM35CCIW-X	D7
TFC10IW-X	K18	WCM35CIW8	D6
TFC3IW-X	K18	WCM35DBFIW	D7
TFC5IW-X	K18	WCM35DW8	D6
TFX10IW-X	K19	WCM35ECIW	D7
TFX3IW-X	K19	WCM35ICIW	D7
TFX5IW-X	K19	WCM35OCIW	D7
TFXD10IW-X	K13	WCM35TI	D7
TG70BCIW-X	E7	WCM35TIW	D7
TG70HB3-X	E8	WCM35TR10IW	D7
TG70HB3GFCI-X	E8	WCM35TR5IW	D7
TG70IW10	E6	WCM35TR70IW	D7
TG70IW8	E6	WCM35TRIW	D7
TG70WR-X	E8	WCM35WR-X	D7
TGBFI	E7	WPS-20	J11
TGBFIW	E7	WPS-202	J11
TGDW10	E6		
TGDW8	E6		
TGECIW	E7		
TGEEIW	E7		
TGFSB	E8		
TGICIW	E7		
TGOCIW	E7		

PANDUIT® is a global leader in wiring and communication products, delivering end-to-end solutions in support of demanding electrical and networking requirements.

PANDUIT® Catalogs

Cable Ties

SA-CTCB03

- *PAN-TY*® Cable Ties
- *PAN-TY*® Clamp Ties
- *PAN-TY*® Push Mount Ties
- *PAN-TY*® Marker Ties
- *DOME-TOP*® Barb Ty Cable Ties
- *DOME-TOP*® Barb Ty Clamp Ties
- *DOME-TOP*® Barb Ty Marker Ties
- *CONTOUR-TY*™ Cable Ties
- *DURA-TY*™ Cable Ties
- *BELT-TY*™ In-Line Cable Ties
- *TAK-TY*® Hook & Loop Cable Ties
- *STA-STRAP*® Cable Ties
- Cable Tie Installation Tools
- Custom Hot Stamping

Wiring Accessories/Abrasion Protection

SA-CTCB03

- Adhesive Backed Cable Tie Mounts
- Screw Applied Cable Tie Mounts
- Flat Cable Mounts
- Fixed Diameter Clamps
- Harness Board Accessories
- Spiral Wrap
- Grommet Edging
- Braided Expandable Sleeving
- Corrugated Loom Tubing and Fittings
- Heat Shrink Tubing
- Non-Shrink PVC Tubing
- *PAN-WRAP*™ Split Harness Wrap

Identification Products

SA-101N315C-ID

- Hand-Held Printers
- Desktop Printers
- Labeling Software
- Computer Printable Labels
- Wire Markers
- Lockout/Tagout Products
- Voltage Markers
- Warning Labels
- Safety Signs and Tags
- Letters and Numbers

Terminals

SA-TM03CB02A

- *PAN-TERM*® Terminals
- Ferrule End Sleeves
- *PAN-TERM*® Disconnects
- *PAN-TERM*® Splices
- *PAN-TERM*® Wire Joints
- Terminal Kits
- Ferrule End Sleeve Kits
- *REEL SMART*™ Terminal Products
- Terminal Installation Tools

Power Connectors

SA101N15C-NL

- Copper Compression Lugs
- Copper Compression Splices
- High Voltage Lugs and Splices
- Compression Taps
- Aluminum Compression Lugs
- Aluminum Compression Splices
- Compression Connector Accessories
- Copper Mechanical Connectors
- Split Bolt Connectors
- Aluminum Mechanical Connectors — Dual Rated Connectors
- Grounding Connectors
- Crimping Tools and Dies

Stainless Steel Products

SA-SSCB06

- *PAN-STEEL*® Stainless Steel Cable Ties
- *PAN-STEEL*® Stainless Steel Strapping
- Installation Tools
- *PAN-STEEL*® System Accessories
- *PAN-STEEL*® System Permanent Identification

Network Connectivity

SA-NCCB04

- Modules
- *ULTIMATE ID*™ System
- Work Area
- Zone Cabling
- Patch Panels, Copper Patch Cords & Punchdowns
- Fiber Connectors, Enclosures & Patch Cords
- Racks & Cable Management
- Grounding and Bonding
- Fiber Routing
- Surface Raceway
- Labeling & Administration
- Cable Ties & Accessories

Wiring Duct

SA-WDCB05

- *PANDUCT*® Slotted Wall Wiring Duct
- *PANDUCT*® Solid Wall Raceway
- *PANDUCT*® Halogen Free Slotted Wall Wiring Duct
- *PANDUCT*® Flush Cover Round Hole Wiring Duct
- *PANDUCT*® Hinged Slotted Wall Wiring Duct
- *PANDUCT*® Flexible Wiring Duct
- *PANDUCT*® Low Smoke Slotted Wall Wiring Duct
- Wiring Duct Accessories and Installation Tools