

0 (0)
0.15 (0.006)
1.65 (0.065)
1.8 (0.071)
3.52 (0.138)
5.2 (0.205)

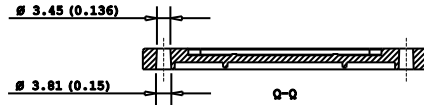

5.2 (0.205)
8.62 (0.34) ± 0.15

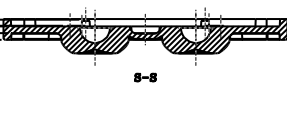

0 (0)
1.65 (0.065)
6.6 (0.26)
7.61 (0.299)

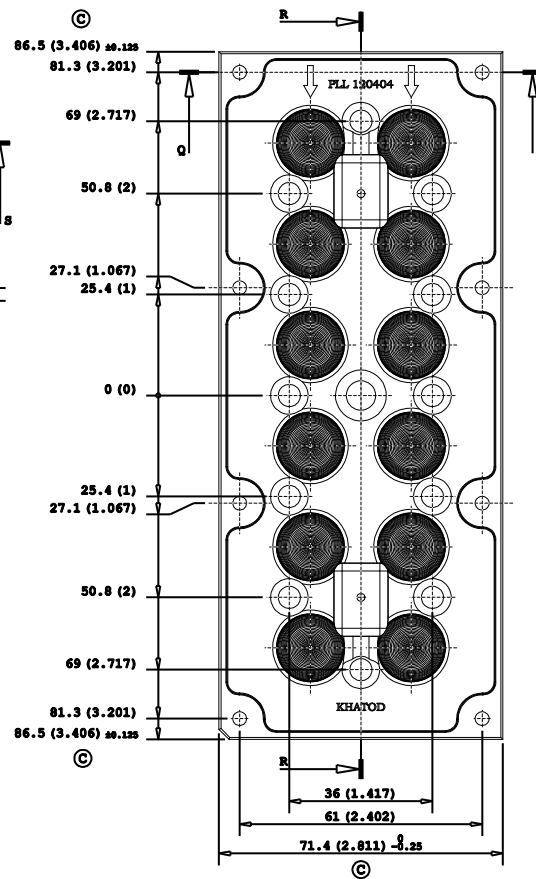
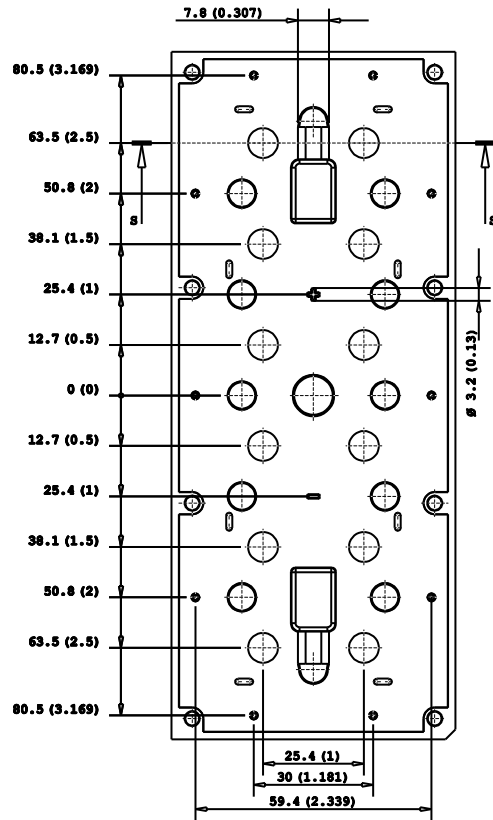
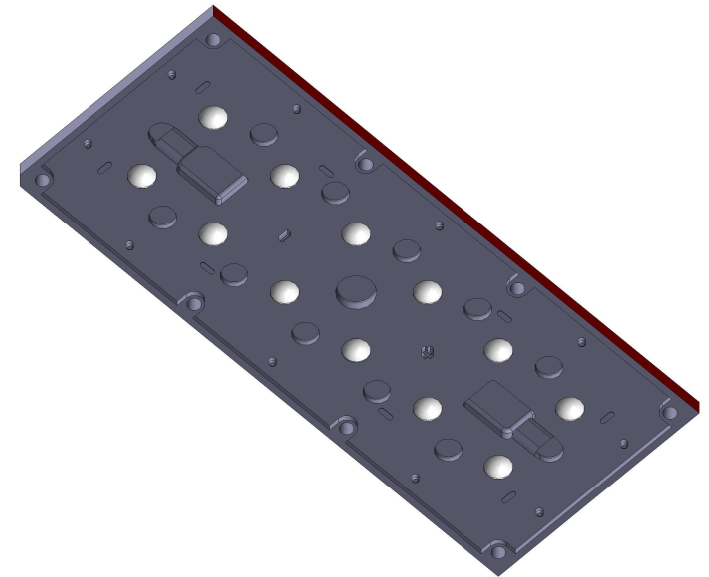
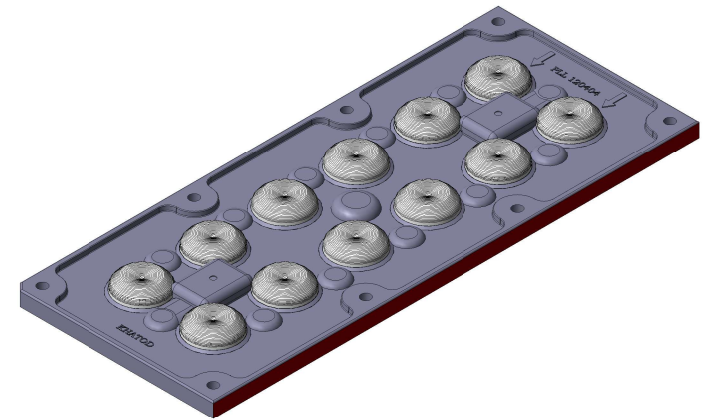
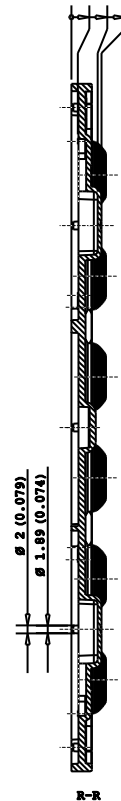

Note:
- Dimensions in inches into brackets
- For missing dimensions see 3D file
- WHITE surfaces: mirror polished
- GREY surfaces: embossed 25/27 VDI
- RED surface: gate area. Sink mark injection will be present
© = Quality Control Dimensions (QCD)
- Planarity tolerance +/- 0.80 mm

** Project and design owned by Khatod OPTOELECTRONIC s. r. l.** The technical solutions adopted in this design are Khatod intellectual property, they cannot be reproduced and transmitted to third parties without our prior written permission. Unauthorized disclosure of confidential proprietary information will be prosecuted by law.			
DESCRIPTION :	12 Array lens	DESIGNER :	LM
PROJECTS :	VI_II	CODE :	PLL 120404
CHECKED :	LS	CONTROLLED:	LS/GV
DATA :	11/11/2016	All Dimensions in mm	
KCHATOD Via Alessandrina, 25 Cusano Milanino MILANO ITALIA WWW.KCHATOD.COM		General Tolerances +/- 0.25 mm	
HEAT TREATMENT: No One		MATERIAL: PMMA 8N	
SCALE : 1 : 1		SHEET : 1 of 1	