

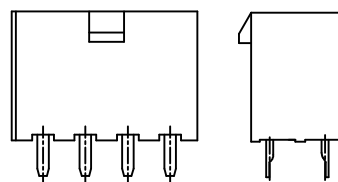

PRODUCT NUMBER
SEE PART NO. TABLE

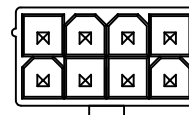

PART WITHOUT PEGS

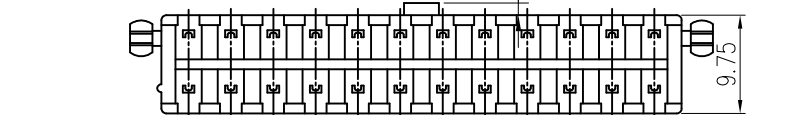
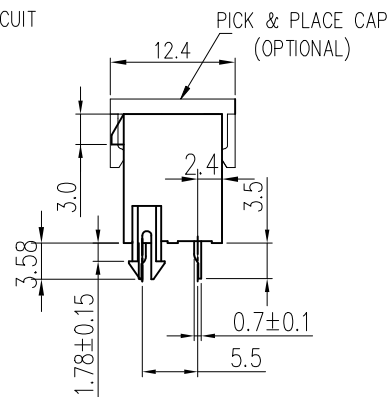
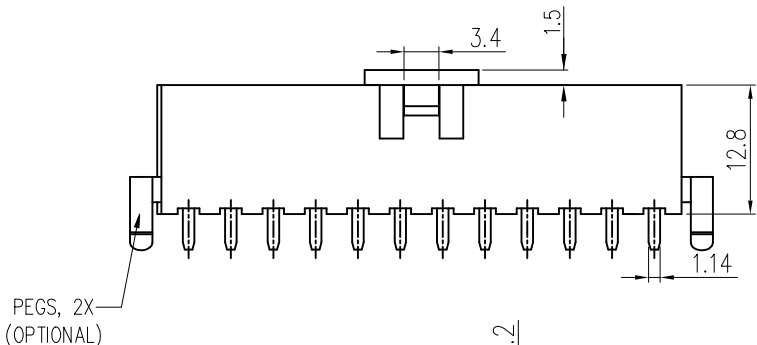
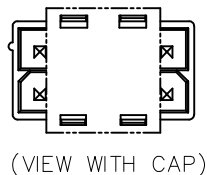
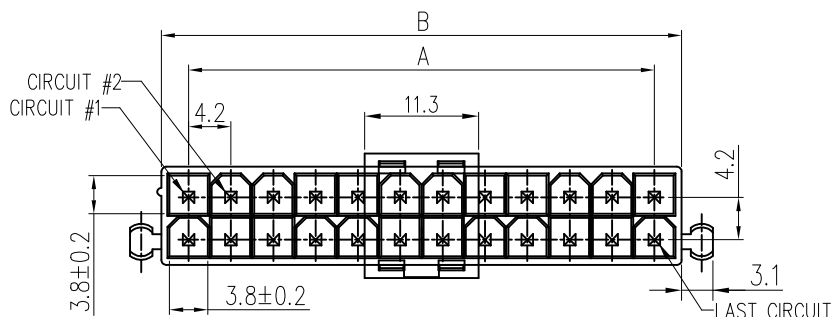
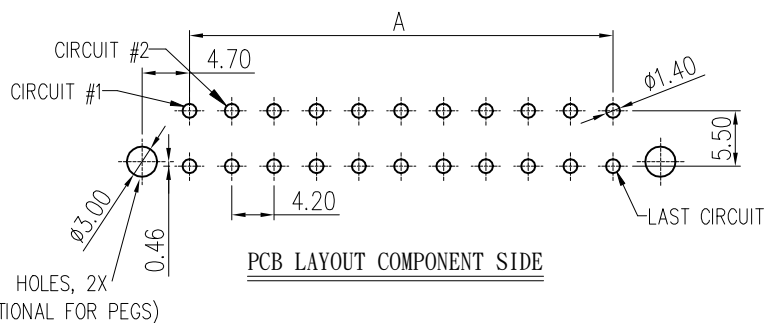

NOTES:

- MATERIAL:
HSG: OPTIONAL, UL94V-0.
COLOR: NATURAL.
TERMINAL: BRASS.
PLATING: 50u" Ni UNDERPLATING; OPTIONAL ON CONTACT AREA.
PICK & PLACE CAP: HIGH TEMP. THERMOPLASTIC
- THIS PLUG MATES WITH FCI RECEPTACLE WIRE CONNECTOR 10127815.
- PRODUCT SPECIFICATION: GS-12-1181.
- PACKAGE SPECIFICATION: GS-14-2362.
- THE HOUSING WILL WITHSTAND EXPOSURE TO 235°C PEAK TEMPERATURE FOR 5 SECONDS IN A WAVE SOLDER APPLICATION WITH A 1.6mm MINIMUM THICK CIRCUIT BOARD. (FOR PA66)
THE HOUSING WILL WITHSTAND EXPOSURE TO 260 °C PEAK TEMPERATURE FOR 10 SECONDS IN A REFLOW OVEN. (FOR LCP ONLY)
- PART NUMBER SCHEME:
10127820- XX X X X X X LF

POS. CODE:	XX X X X X X LF	BLANK: NO CAP, TRAY PACKAGE
02: 2 POS.		C: WITH CAP, TAPE/REEL PACKAGE
04: 4 POS.		T: NO CAP, TAPE/REEL PACKAGE (CAP NOT APPLICABLE FOR 2 POS.)
24: 24 POS.		PEG: NO PEG
		BLANK: NO PEG
		P: 2 PEGS
TERMINAL MATERIAL:		BLANK: NO PEG COMPATIBLE:
2: BRASS, TAIL LENGTH 3.5mm		BLANK: PA66, NON COMPATIBLE
3: BRASS, TAIL LENGTH 1.9mm		G: PA66, COMPATIBLE
		L: LCP, COMPATIBLE
PLATING CODE:		
1: GOLD FLASH		
2: TIN		
4: 30u" Au		
S: GOLD FLASH ON ONCONTACT, MATTE TIN ON TAILS		

7. DIMENSIONAL & PART NO. TABLE:

PART NUMBER	POS.	A	B
10127820-02XXXXLF	02	4.2	5.4
10127820-04XXXXLF	04	8.4	9.6
10127820-06XXXXLF	06	12.6	13.8
10127820-08XXXXLF	08	16.8	18.0
10127820-10XXXXLF	10	21.0	22.2
10127820-12XXXXLF	12	25.2	26.4
10127820-14XXXXLF	14	29.4	30.6
10127820-16XXXXLF	16	33.6	34.8
10127820-18XXXXLF	18	37.8	39.0
10127820-20XXXXLF	20	42.0	43.2
10127820-22XXXXLF	22	46.2	47.4
10127820-24XXXXLF	24	50.4	51.6

mat'l. code		surface		tolerance		projection		product family	
litr		ecn no		dr		date		Minitek Pwr4.2	
H		ELX-T-20468		TAI		2015-03-16		title	
J		ELX-T-21113		TAI		2015-06-09		MINITEK PWR4.2, WTB HEADER, DUAL ROW, VERTICAL, DIP TYPE	
K		ELX-T-21843		TAI		2016-06-02		scale	
L		ELX-T-26123		TAI		2017-02-20		dr	
M		ELX-N-26497		TONY		2017-03-29		engr	
G		ELX-T-20255		TAI		2015-02-12		appd	
sheet		revision		M		M		FCI	
index		sheet		1		2		type	
								CUSTOMER Drawing	

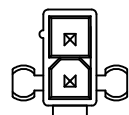

2 POS

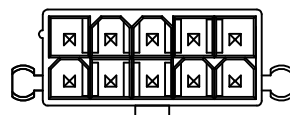

10 POS

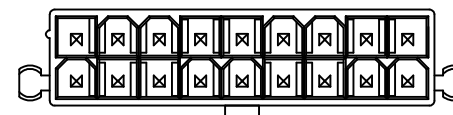

18 POS

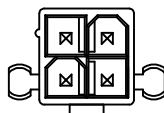

4 POS

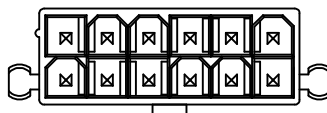

12 POS

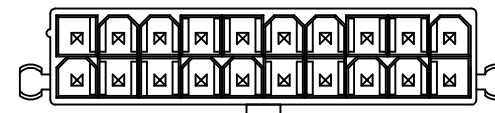

20 POS

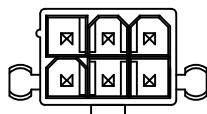

6 POS

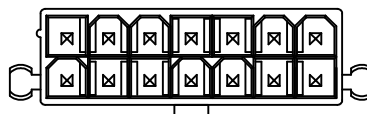

14 POS

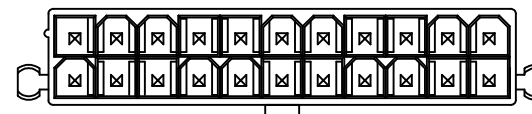

22 POS

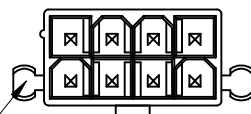

8 POS

WITH PEG

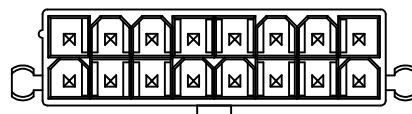

16 POS

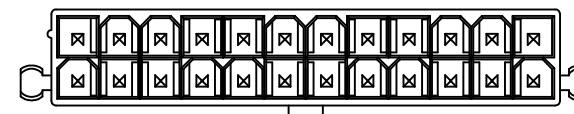

24 POS

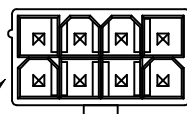

VIEW WITHOUT PEG

NO PEG

mat'l. code		surface	tolerance	projection	product family Minitek Pwr4.2	
ltr	ecn no	dr	date	tolerances unless otherwise specified		title
				angles	X.X ±0.4	MINITEK PWR4.2, WTB HEADER, DUAL ROW, VERTICAL, DIP TYPE
				linear	X.XX ±0.3	
				X'±1'		
		dr	KENNY TAI	2013-11-11	scale	dwg no
		enr	KENNY TAI	2013-11-11	MM	
		chr	KENNY TAI	2013-11-11		FCI
		appd	PM ZHENG	2013-11-22	type	
sheet index	revision	M	M			
	sheet	1	2			